

*Captive*TM
by Cifre

C A P T I V A T I N G M A T E R I A L S

*Captive*TM
by Cifre

*Grupo Cifre
es una empresa
en evolución constante*

Adapta, crece, se revoluciona.
Busca la innovación y la mejora constante tanto en producto como en servicios a sus clientes. Es una empresa joven que ha crecido y evolucionado con el sector, que ha sabido adaptarse y evolucionar según las necesidades y la realidad del mercado.

Grupo Cifre ha hecho de esta agilidad y capacidad de adaptación una filosofía empresarial que le ha llevado a consolidarse como una empresa de referencia en el sector cerámico y a ampliar los mercados y los países en los que está presente.

Cada novedad es un reto y cada reto es un aliciente para una empresa que busca superarse y ser cada vez mejor.

Grupo Cifre is a company that is constantly evolving.

Adapting, growing, constantly re-inventing itself.
Seeking to innovate and endeavouring to improve its products and its services for customers. It is a young company that has grown and evolved with the industry, and it has been able to adapt and develop to suit the market and its needs.

Grupo Cifre has turned this nimbleness and adaptability into a business philosophy that has enabled it to consolidate its position as a landmark company in the ceramics industry, to enter new markets and to extend its global reach into more countries.

Every new development is a challenge and every challenge is an incentive for a company that is constantly trying to surpass itself and become better every day.

Grupo Cifre est une entreprise en constante évolution.

Elle adapte, croît, se révolutionne.
Elle recherche l'innovation et l'amélioration constante aussi bien en matière de produits qu'en services à ses clients. Elle est une entreprise jeune qui a grandi et évolué avec le secteur, qui a su s'adapter et évoluer selon les besoins et la réalité du marché.

Grupo Cifre a fait de cette flexibilité et capacité d'adaptation une philosophie d'entreprise qui lui a permis de se consolider comme une entreprise de référence au sein du secteur céramique et d'élargir les marchés et les pays dans lesquels elle est présente.

Chaque nouveauté est un défi et chaque défi est un attrait pour une entreprise qui cherche à se surpasser et à devenir sans cesse meilleure.



*Captive*TM by Cifre

Unos materiales capaces de seducir y de conmovir. Los brillos, las texturas, la proximidad de la naturaleza. El calor de los dorados y la sensación de frescura de los materiales naturales. La vida como un escenario, como lugares en los que todo es posible, ese punto en el que se centran todos los focos. Ahí es donde vive la cerámica de *Captive by Cifre*. Es la cerámica que enmarca la vida en un telón, que dibuja los espacios más especiales y que convierte lo cotidiano en extraordinario.

Captive es la dualidad entre los materiales más sofisticados y los más naturales. Entre Mosaic y Stone.

Materials capable of moving you and seducing you. Glints, textures, the proximity of nature. Gilded warmth and the fresh feeling of natural materials. Like life on the stage, in places where everything is possible, in the place where all the spotlights come together. This is where *Captive* ceramics by Cifre are in their element. The ceramic that creates the setting, shaping unique spaces and turning the everyday into a special event.

Captive is that special place where the most sophisticated and the most natural materials meet. Mosaic and Stone.

Des matériels capables de séduire et d'émouvoir. Les brillances, les textures, la proximité de la nature. La chaleur des dorés et la sensation de fraîcheur des matériaux naturels. La vie comme une scène, comme des endroits où tout est possible, ce point où se centrent toutes les attentions. C'est à cet endroit que vit la cerámica de *Captive by Cifre*. C'est la cerámica qui inscrit la vie dans un rideau de fond, qui dessine les espaces les plus spéciaux et qui fait du quotidien un événement extraordinaire.

Captive est la dualité entre les matériels les plus sophistiqués et les plus naturels. Entre Mosaic et Stone.

MOSAIC

STONE



Captive[™]
MOSAIC



Captive[™]
STONE



Captive[™]
by Cifre

Es la cerámica que cautiva.
La que deja huella. La que hace que no haga falta mirar alrededor.
La que dibuja momentos que brillan con luz propia.
La que traza los mejores recuerdos.
Captive es la cerámica más seductora de Cifre, compuesta por destellos,
por reflejos, por el tacto suave de una piedra natural.
Es la puerta a un mundo en el que siempre querrás quedarte.

The ceramic that captivates.
The ceramic that makes its mark. The one that means there's no need to look elsewhere.
The one that shapes moments that shine with their own light.
The one that evokes the best memories.
Captive is the most seductive ceramic by Cifre, made up of gleams,
reflections, the smooth touch of natural stone.
The gateway to a world where you will want to stay forever.

C'est la céramique qui captive.
Celle qui laisse une trace. Celle qui fait qu'il ne soit pas nécessaire de regarder autour.
Celle qui dessine des moments qui brillent d'une lumière personnelle.
Celle qui trace les meilleurs souvenirs.
Captive est la céramique la plus séduisante de Cifre, composée d'éclats,
de reflets, du doux toucher d'une pierre naturelle.
C'est la porte vers un monde que vous ne voudrez jamais quitter.



*Captive*TM MOSAIC

Entra en lugares en los que la cerámica brilla, asume el protagonismo.
En escenarios contruidos a base de brillos, de reflejos limpios, de colores y de tactos naturales.
Captive Mosaic dibuja espacios en los que ser protagonista, conquistador, sofisticado, único.

Plays the leading role in settings where ceramics shine out.
Bringing to the fore their gleams, limpid reflections, natural colours and feel.
Captive Mosaic defines spaces to play the leading role, to triumph, sophisticated and unique.

Elle entre dans des lieux où la céramique brille, elle assume son premier rôle.
Dans des scènes construites à base de brillances, de reflets propres, de couleurs et de touchers naturels.
Captive Mosaic dessine des espaces dans lesquels elle est protagoniste, conquérante, sophistiquée, unique.

cifre

10

GOLD stage





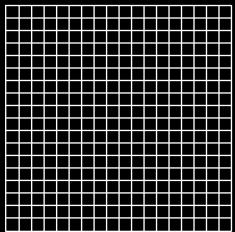

MOSAICO SIRICO / ESMIRNA
30 x 30 cm / 11,7 x 11,7"
 15 x 15 x 7,5 mm

GOLD stage



Mosaico Sirico White



Mosaico Sirico Blue



Mosaico Esmirna

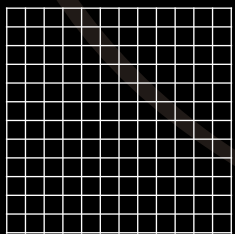

MOSAICO CAMAIORE FLOWER
30 x 30 cm / 11,7 x 11,7"

 23 x 23 x 8 mm

MOSAICO VIGNOLA
30 x 30 x cm / 12 x 12"

 23 x 23 x 7,5 mm

GOLD stage

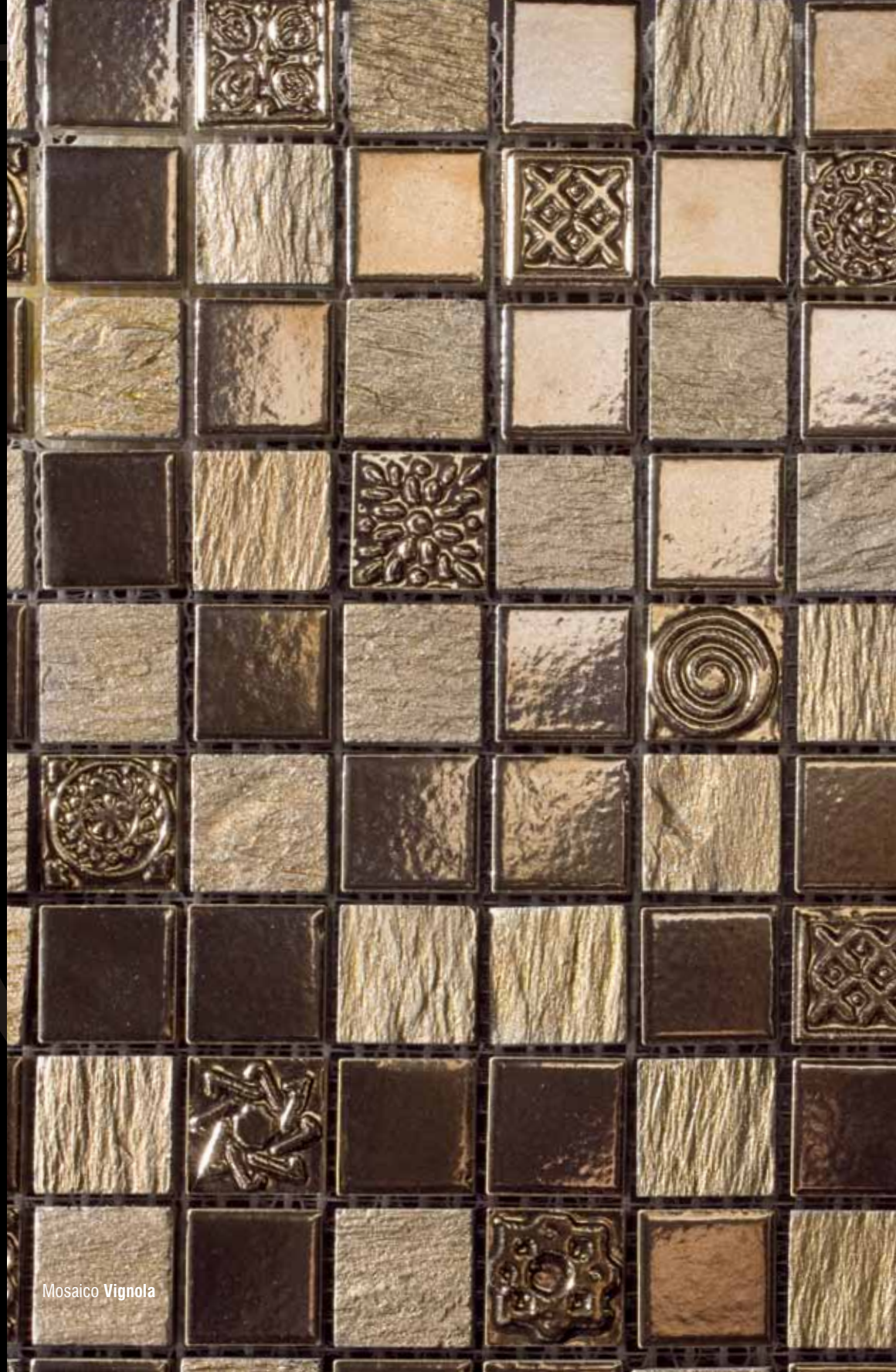

Mosaico Vignola



Mosaico Camaioire Flower



Mosaico Isis

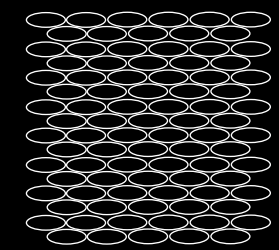

MOSAICO ISIS
30 x 30 cm / 11,7 x 11,7"
■ 20 x 50 x 6 mm

GOLD stage





Mosaico Tirreno Iris White

Mosaico Tirreno Iris Black

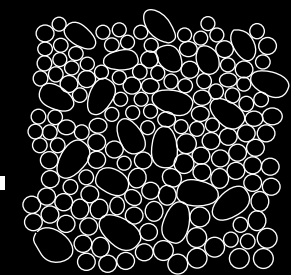

Mosaico Tirreno Iris
30,5 x 30,5 cm / 12 x 12"
■ 17-19 / 30-40 mm

GOLD stage

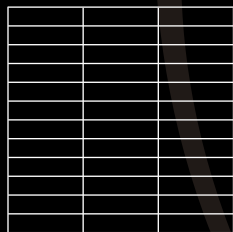

BRICK METÁLICO
29,8 x 29,8 cm / 11,6 x 11,6"
 23 x 98 x 8 mm

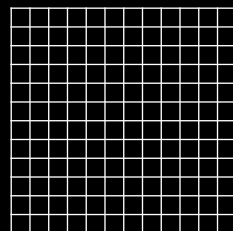

MOSAICO ARETUSA
30 x 30 cm / 11,7 x 11,7"
 23 x 23 x 8 mm

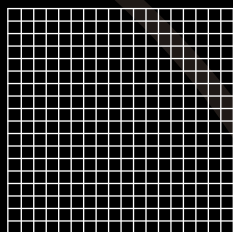

MOSAICO TRACIA / CASANDRA
30 x 30 cm / 11,7 x 11,7"
 15 x 15 x 7,5 mm

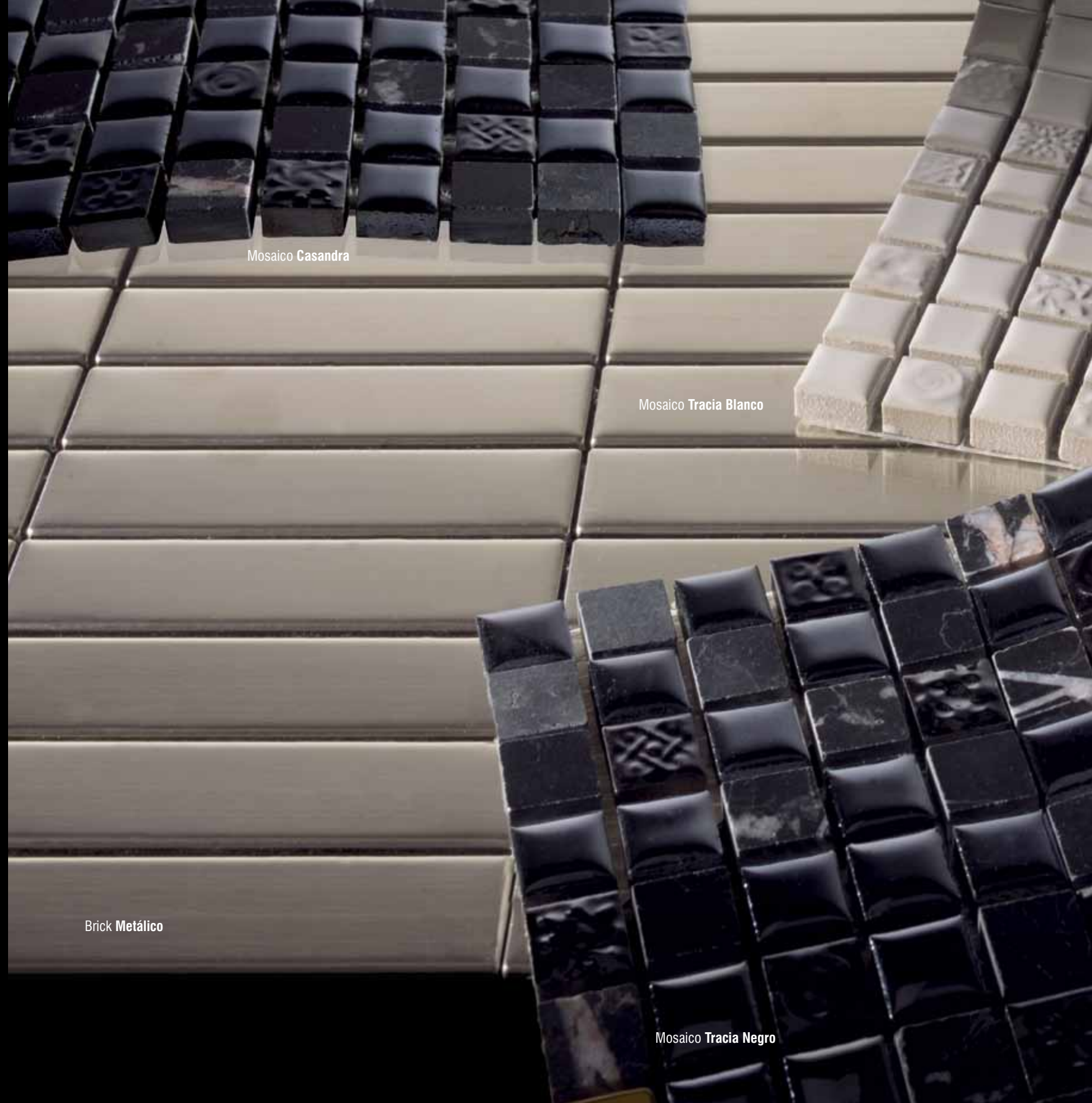

Mosaico Casandra

Mosaico Tracia Blanco

Brick Metálico

Mosaico Tracia Negro

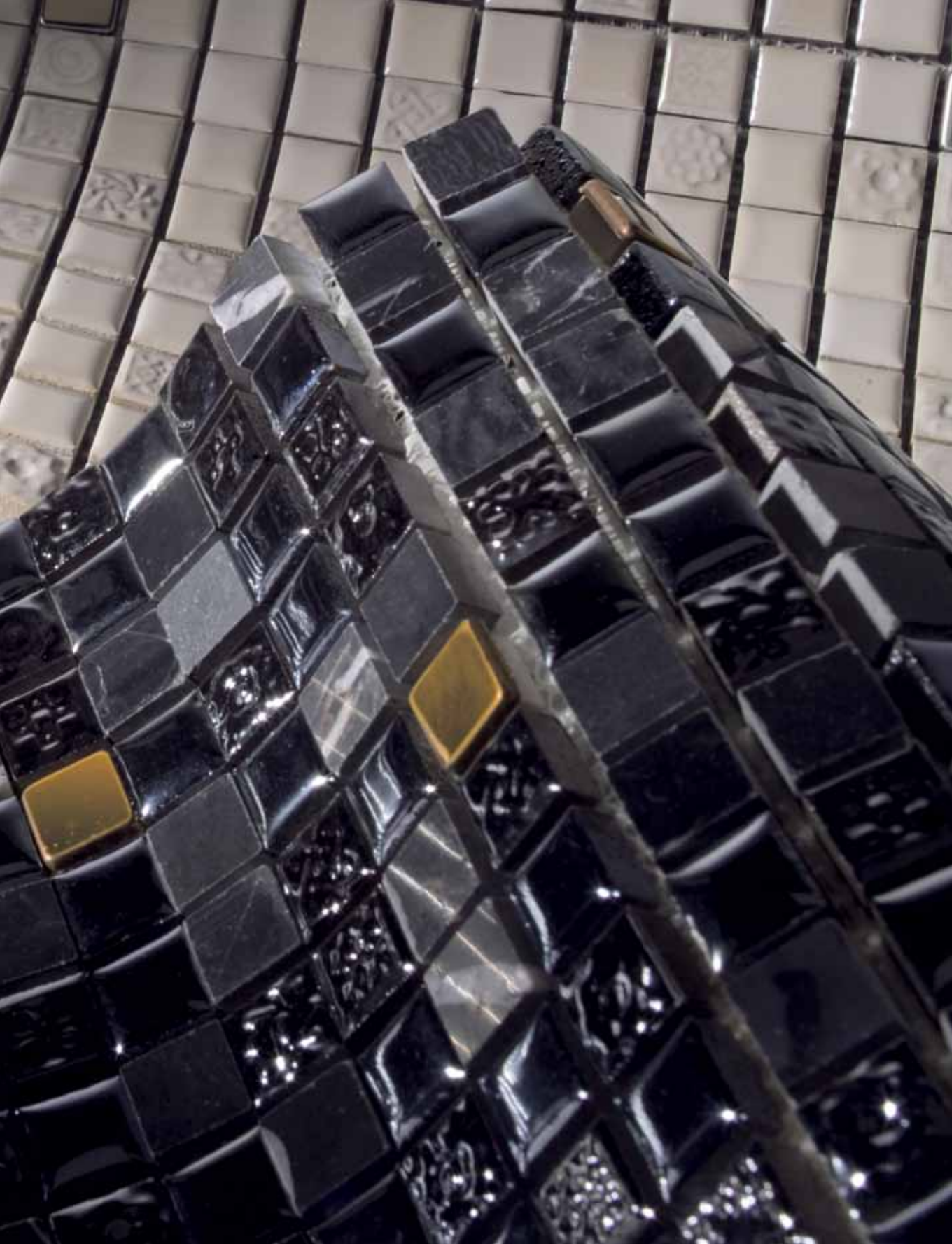

Mosaico Aretusa

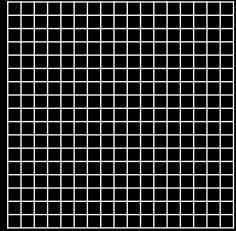

MOSAICO MURANO
30 x 30 cm / 11,7 x 11,7"
16,2 x 16,2 x 4 mm

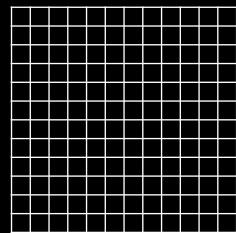

MOSAICO TRENTO
30 x 30 cm / 11,7 x 11,7"
23 x 23 x 7,5 mm

GOLD stage



Mosaico Murano Negro





Mosaico Murano Bianco

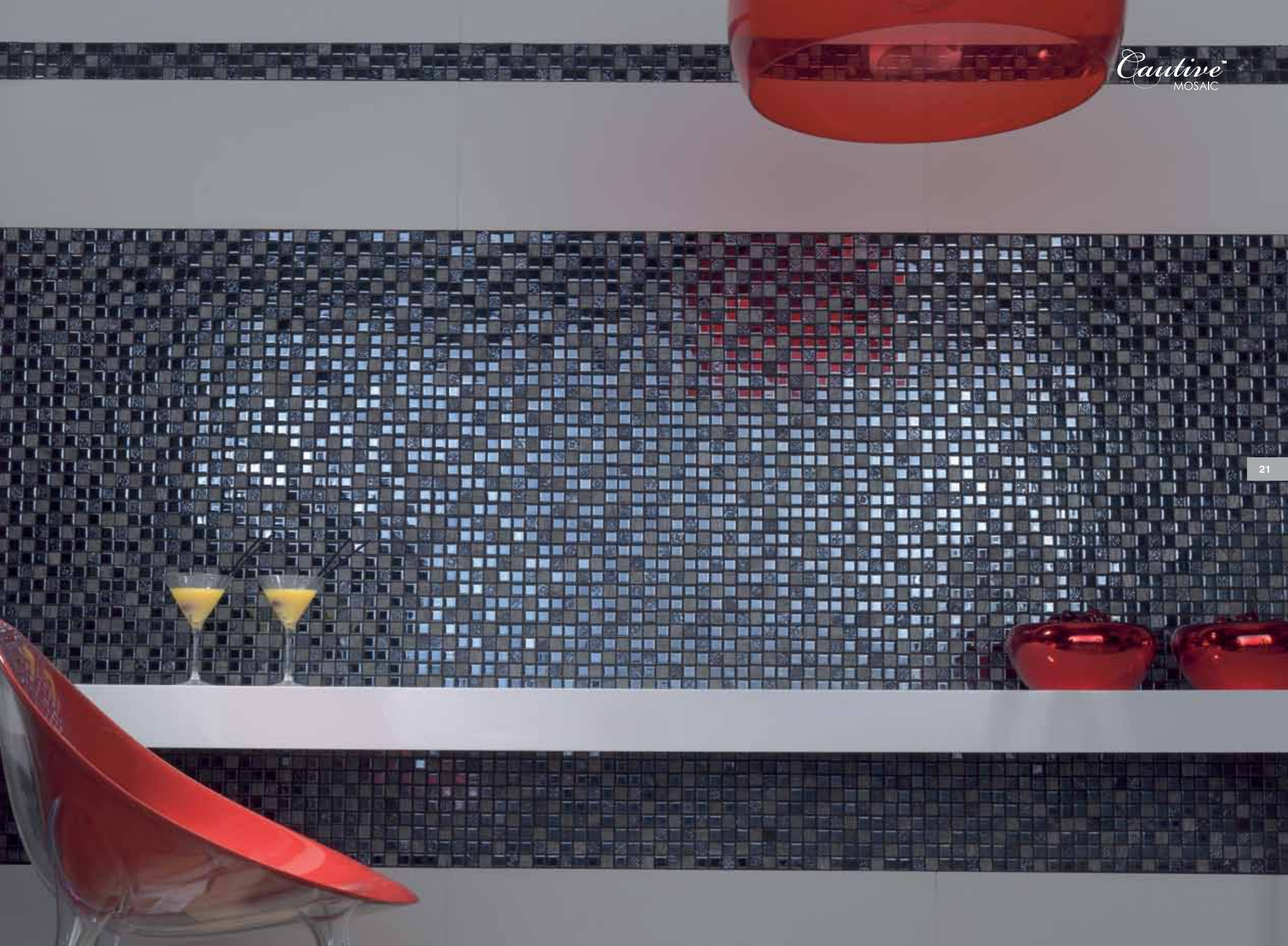

Mosaico Trento

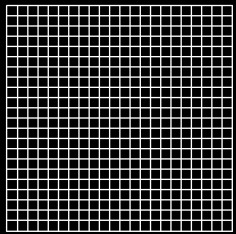



MOSAICO NERVA, IBERIA, FERRARA
30 x 30 cm / 11,7 x 11,7"
 11,5 x 11,5 x 7,5 mm

GOLD stage



Mosaico Nerva



Mosaico Iberia





Decor Teramo

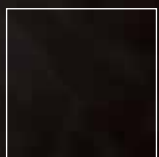

DECOR TERAMO
20 x 20 / 7,8 x 7,8"

 200 x 200 x 25 mm



MOLDURA TERAMO
6 x 30 / 2,3 x 11,7"

 60 x 300 x 25 mm





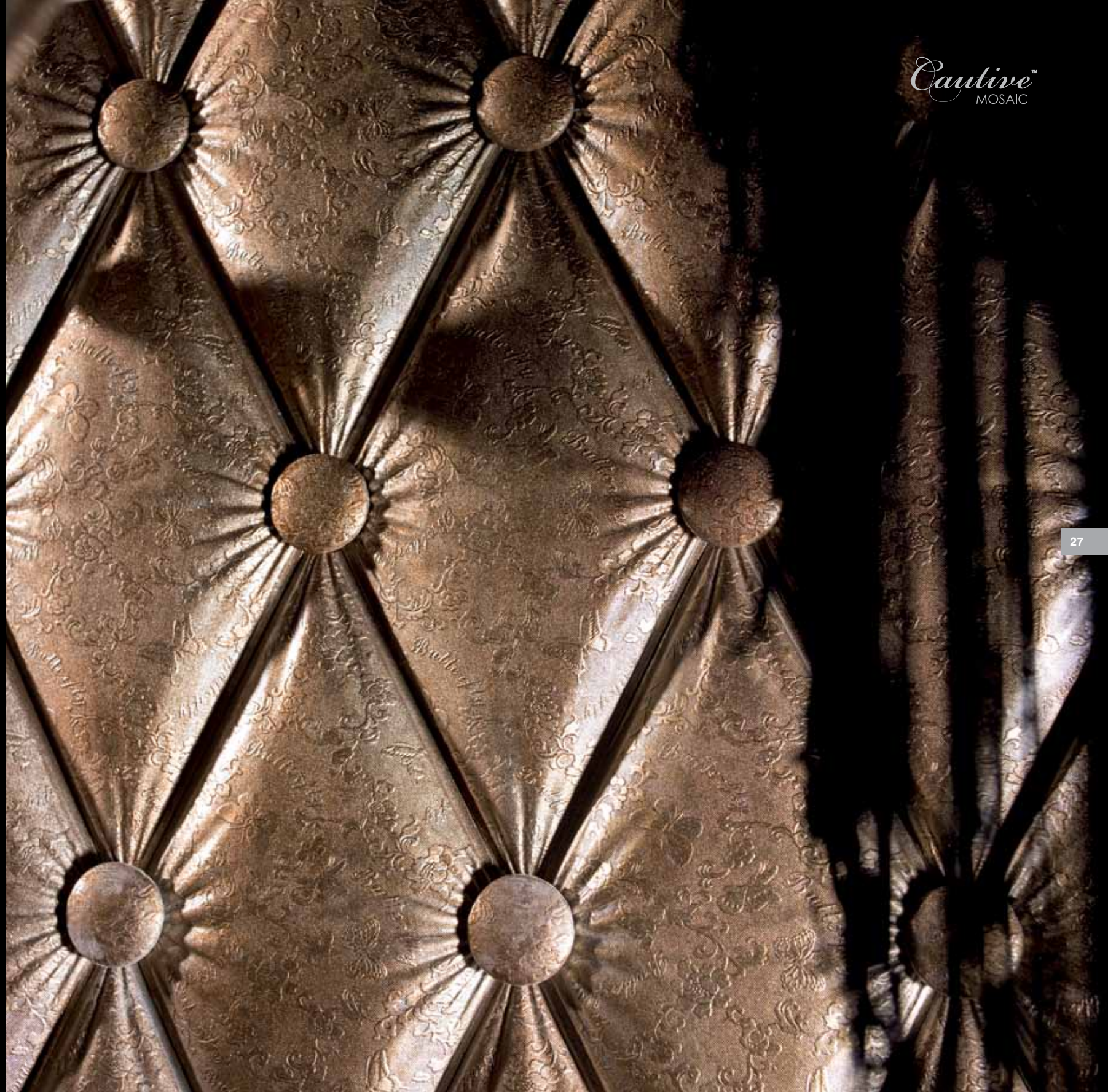

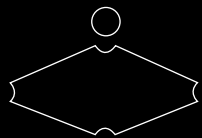

DECOR MONTELLA
12 x 25 / 4,7 x 9,8"
 120 x 250 x 25 mm



MOLDURA MONTELLA
6 x 30 / 2,3 x 11,7"
 60 x 300 x 25 mm



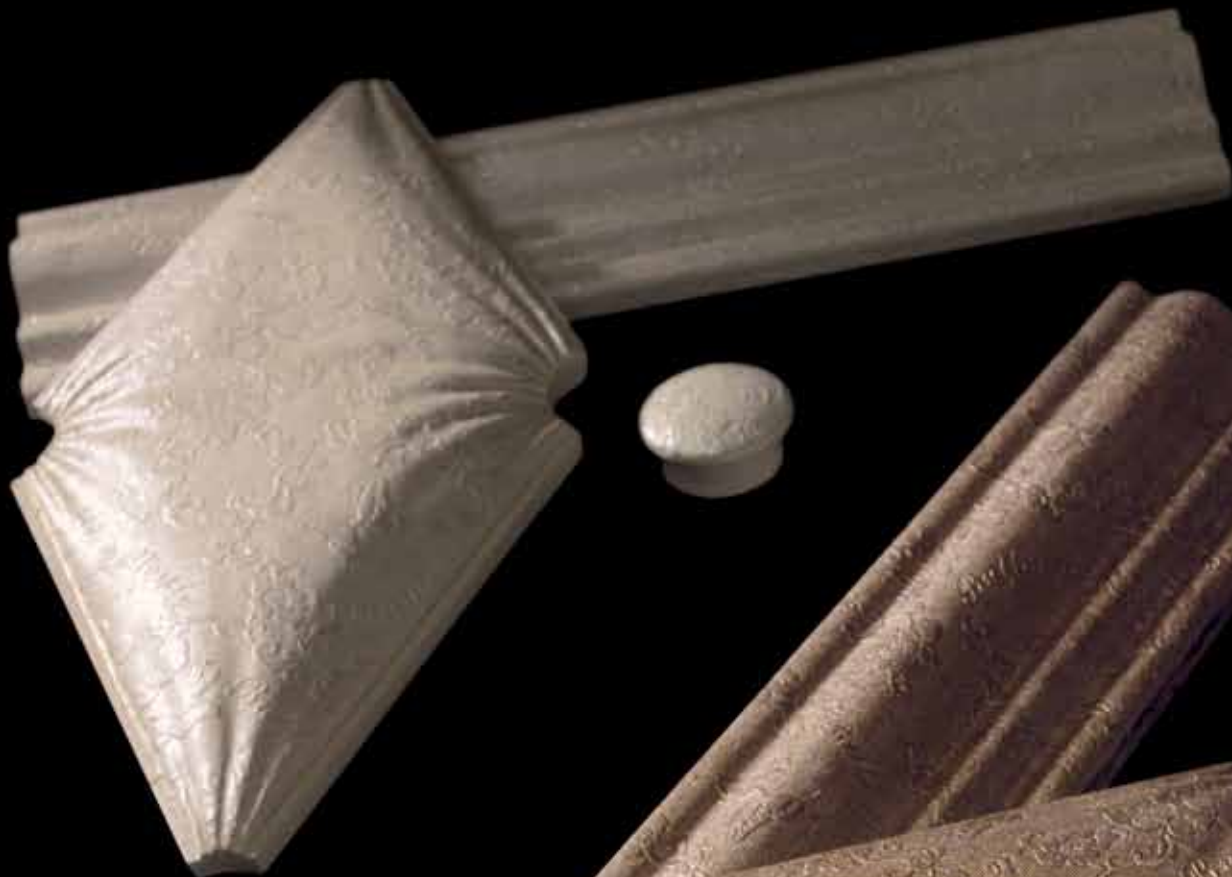

Decor Montella White



Decor Montella Noce

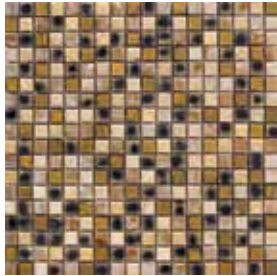

MOSAICO SIRICO BLUE
30 x 30 cm / 11,7 x 11,7"
SP2050

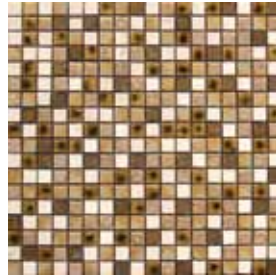

MOSAICO SIRICO WHITE
30 x 30 cm / 11,7 x 11,7"
SP2050

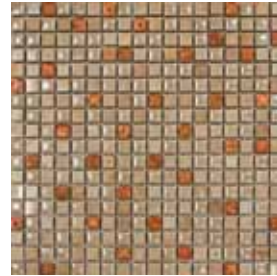

MOSAICO ESMIRNA
30 x 30 cm / 11,7 x 11,7"
SP2041



MOSAICO VIGNOLA
30 x 30 cm / 11,7 x 11,7"
SP2041



MOSAICO CAMAIORE FLOWER
30 x 30 cm / 11,7 x 11,7"
SP2041

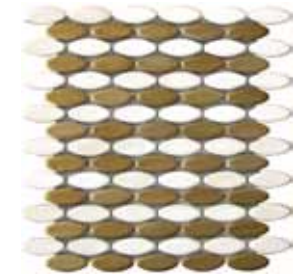

MOSAICO ISIS
30 x 30 cm / 11,7 x 11,7"
SP2032



MOSAICO TIRRENO IRIS BLACK
30,5 x 30,5 cm / 11,9 x 11,9"
SP2032



MOSAICO TIRRENO IRIS WHITE
30,5 x 30,5 cm / 11,9 x 11,9"
SP2032



BRICK METÁLICO
29,8 x 29,8 cm / 11,6 x 11,6"
SP2055

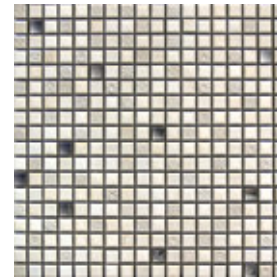

MOSAICO TRACIA BLANCO
30 x 30 cm / 11,7 x 11,7"
SP2032



MOSAICO TRACIA NEGRO
30 x 30 cm / 11,7 x 11,7"
SP2032



MOSAICO CASANDRA
30 x 30 cm / 11,7 x 11,7"
SP2032



MOSAICO TRENTO
30 x 30 cm / 11,7 x 11,7"
SP2038



MOSAICO MURANO BLANCO
30 x 30 cm / 11,7 x 11,7"
SP2042

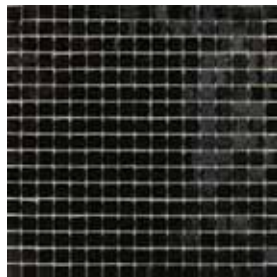

MOSAICO MURANO NEGRO
30 x 30 cm / 11,7 x 11,7"
SP2042

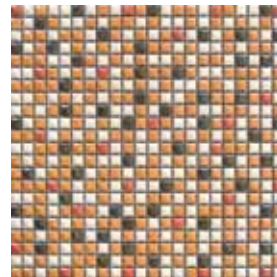

MOSAICO NERVA
30 x 30 cm / 11,7 x 11,7"
SP2032

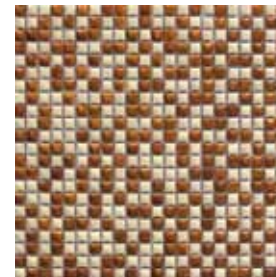

MOSAICO IBERIA
30 x 30 cm / 11,7 x 11,7"
SP2032

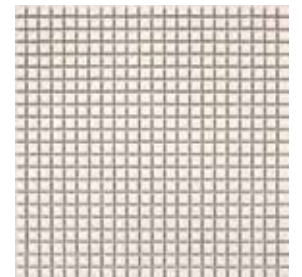

MOSAICO FERRARA
30 x 30 cm / 11,7 x 11,7"
SP2038



MOSAICO **ARETUSA**
30 x 30 cm / 11,7 x 11,7"
SP2032



DECOR **TERAMO**
20 x 20 cm / 7,8 x 7,8"
SP2031



MOLDURA **TERAMO**
6 x 30 / 2,3 x 11,7"
SP2024



DECOR **MONTELLA WHITE**
12 x 25 / 4,7 x 9,8"
SP2027



DECOR **MONTELLA NOCE**
12 x 25 cm / 4,7 x 9,8"
SP2027



MOLDURA **MONTELLA WHITE**
6 x 30 / 2,3 x 11,7"
SP2024



MOLDURA **MONTELLA NOCE**
6 x 30 / 2,3 x 11,7"
SP2024

PACKING LIST

DESCRIPCIÓN DESCRIPTION	FORMATO SIZE FORMAT	MEDIDA MEASURE	PZ/CAJA PC/BOX PZ/CAISE	PESO/PZ WEIGHT/PZ POIDS/PZ	PESO/CAJA WEIGHT/BOX POIDS/CAISSE
Ferrara	30x30	11,5x11,5x7	11	1,00	11,00
Teramo Decor	20x20	200x200	15	1,18	17,7
Montella Noce Decor	12x25	250x120	20	0,45	9,00
Montella White Decor	12x25	250x120	20	0,45	9,00
Camaiore Flower Mosaico	30x30	23x23x8	11	1,50	16,50
Esmirna Mosaico	30x30	15x15x7,5	11	1,30	14,34
Iberia	30x30	11,5x11,5x7,5	11	1,00	11,00
Isis	30x30	20x50x6	11	1,00	11,00
Nerva	30x30	11,5x11,5x7,5	11	1,00	11,00
Sirico Blue	30x30	15x15x7,5	11	1,30	14,34
Sirico White	30x30	15x15x7,5	11	1,30	14,34
Trento Mosaico	30x30	23x23x7,5	11	1,48	16,23
Tracia Blanco	30x30	15x15x7,5	11	1,30	14,34
Tracia Negro	30x30	15x15x7,5	11	1,30	14,34
Vignola Mosaico	30x30	23x23x7,5	11	1,48	16,23
Montella Noce Moldura	6x30	300x60x25	20	0,71	14,12
Montella White Moldura	6x30	300x60x25	20	0,71	14,12
Teramo Moldura	6x30	300x60x25	20	0,71	14,12
Brick Metálico	29,8x29,8	23x98x8	11	1,65	18,11
Tirreno Iris Negro Malla	30,5x30,5	17-19/30-40	10	1,23	12,31
Tirreno Iris Blanco Malla	30,5x30,5	17-19/30-40	10	1,23	12,31
Murano Blanco Mosaico	30x30	16,2x16,2x4	12	0,88	17,50
Murano Negro Mosaico	30x30	16,2x16,2x4	12	0,88	17,50
Casandra Mosaico	30x30	15x15x7,5	10	1,30	13,00
Aretusa Mosaico	30x30	23x23x8	10	1,50	15,00

cifre

32

Glass stage

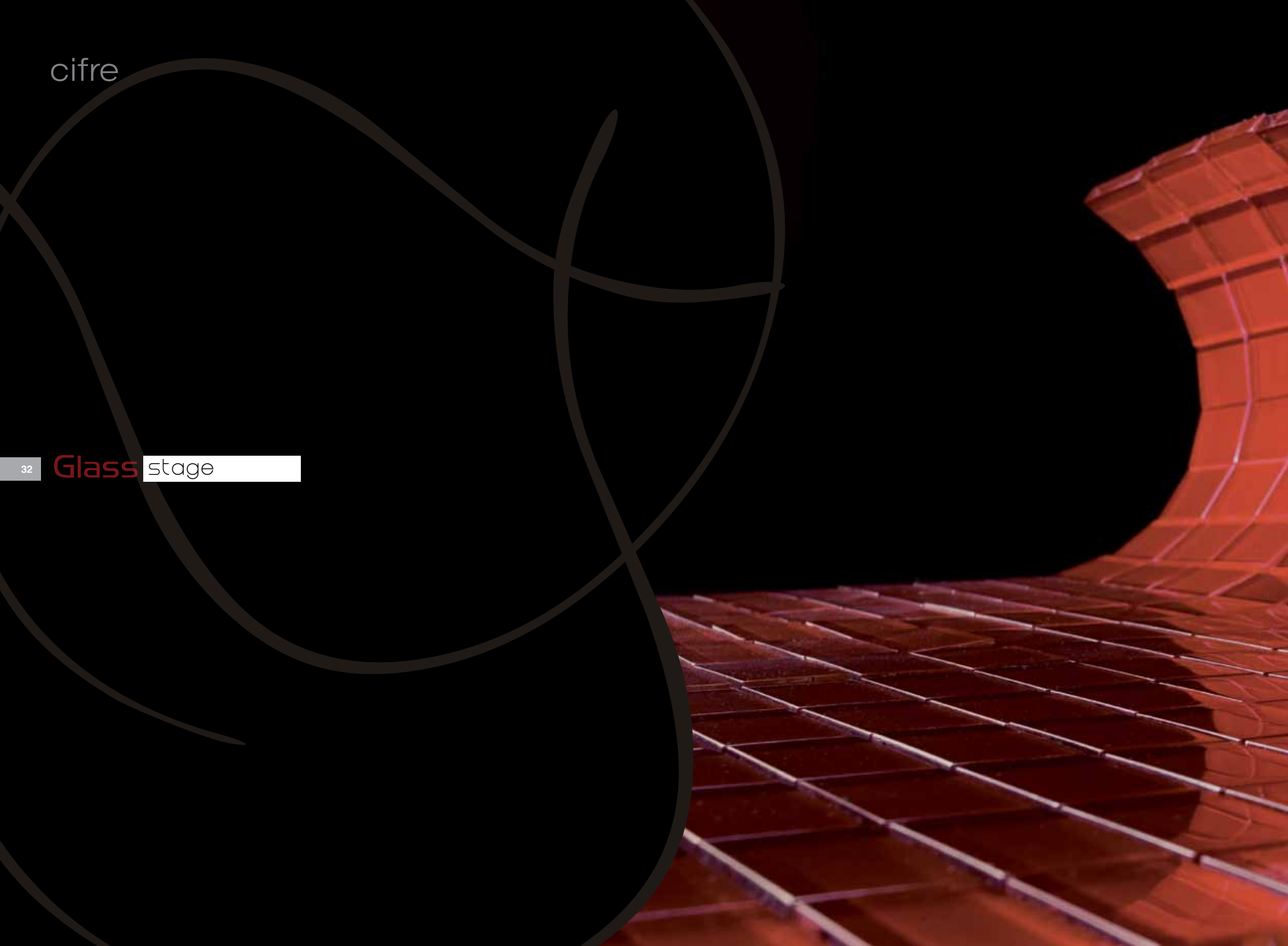

cifre

34





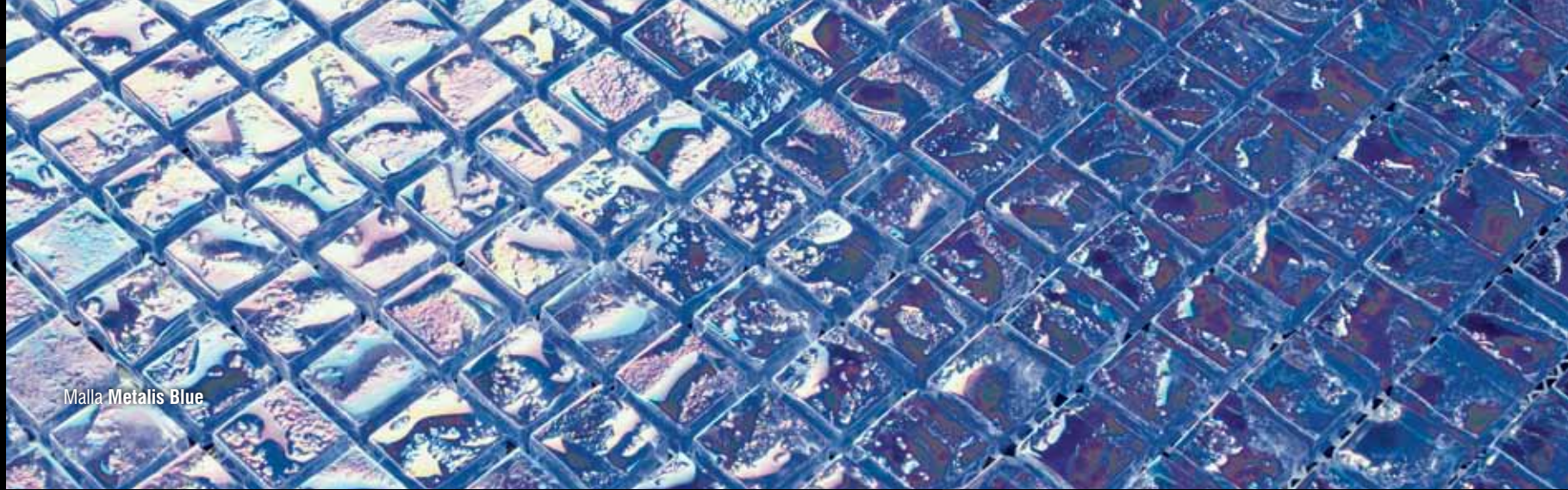

Malla Metalis Blue

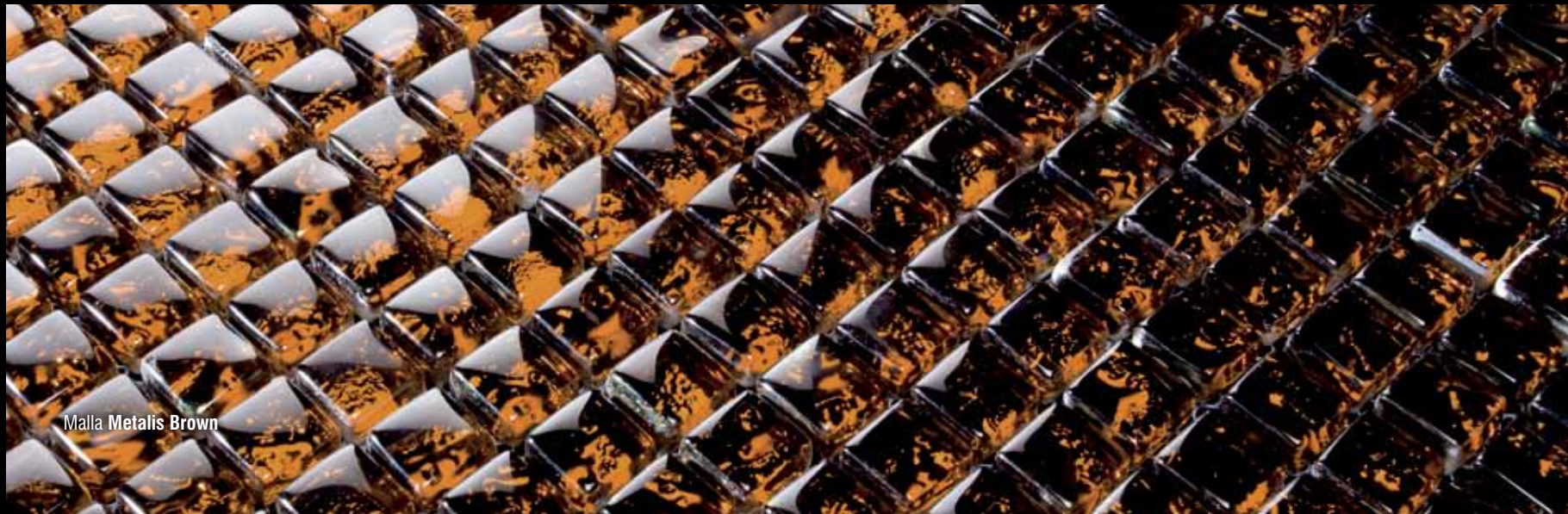

Malla Metalis Brown

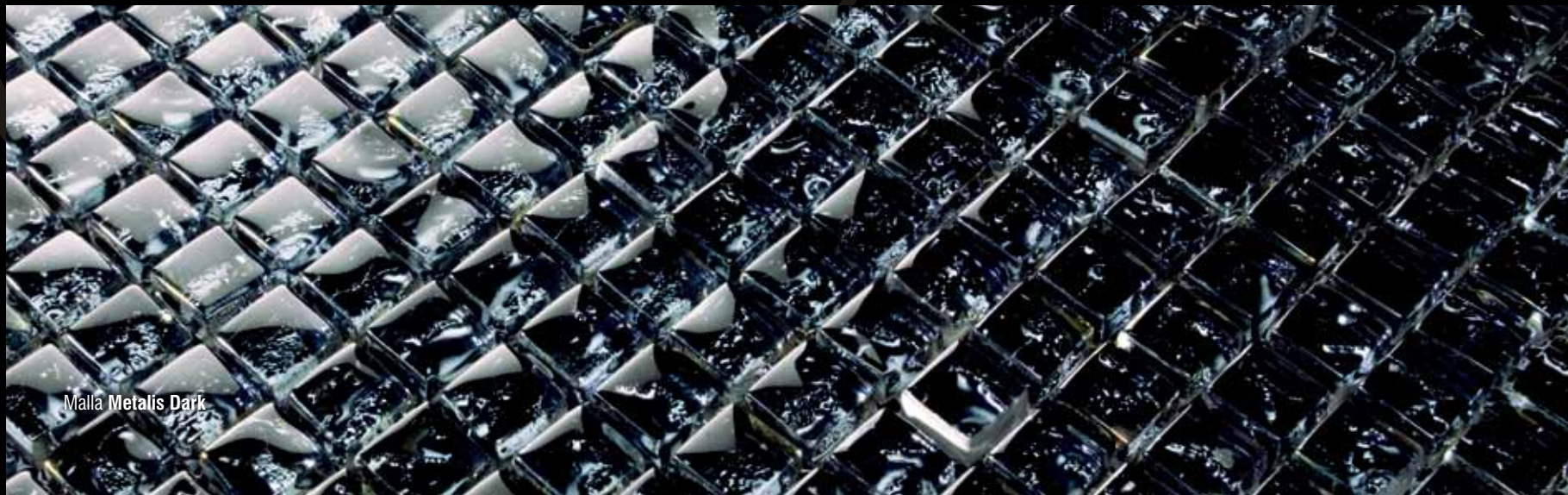

Malla Metalis Dark

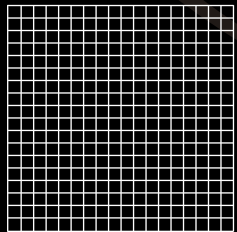

MALLA METALIS
30,1 x 30,1 cm / 11,7 x 11,7"
 15 x 15 x 8 mm



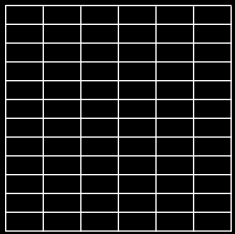
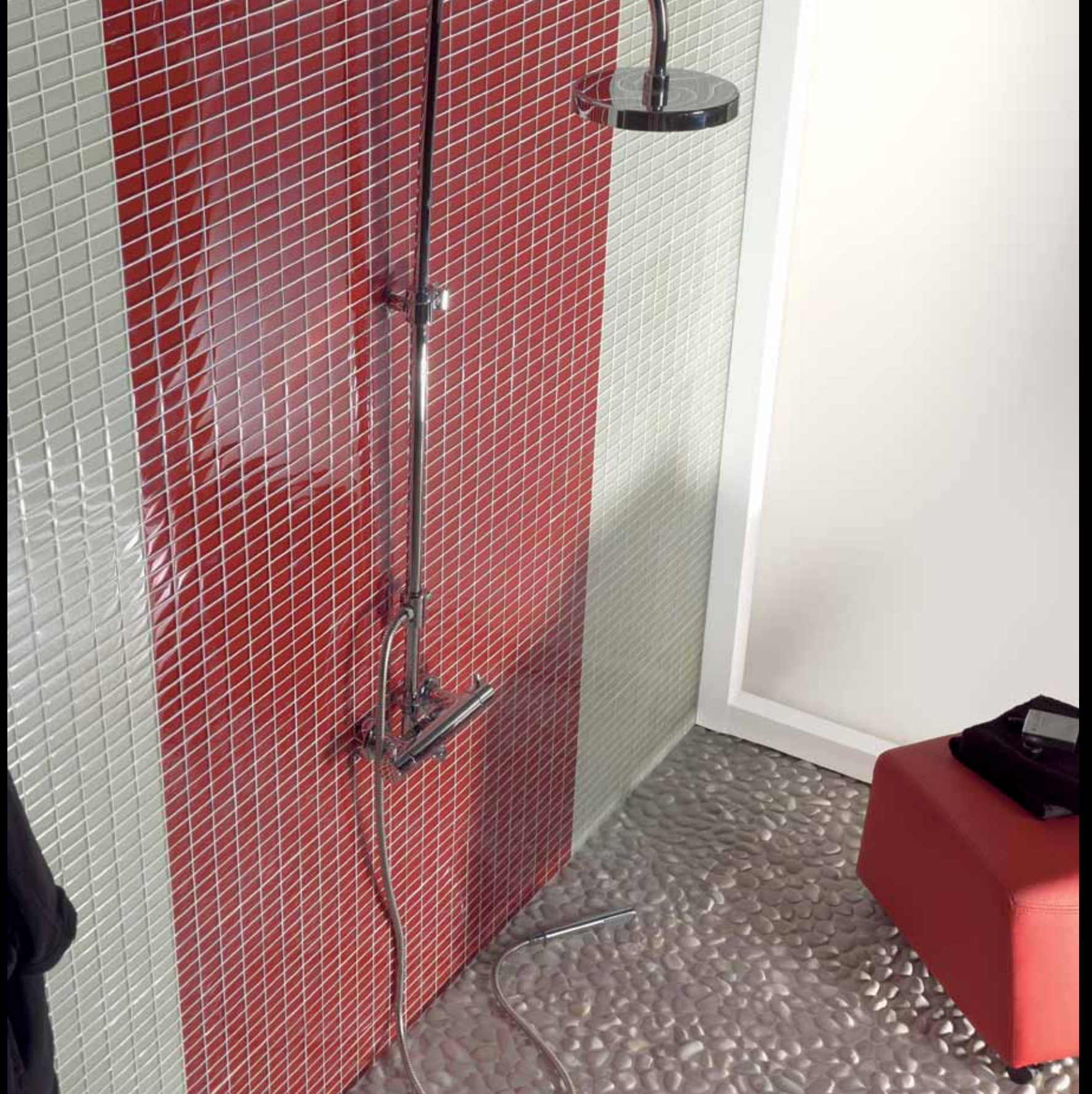

TESELA LECCE
30 x 30 cm / 11,7 x 11,7"
 23 x 48 x 8 mm



Tesela Lecce Black

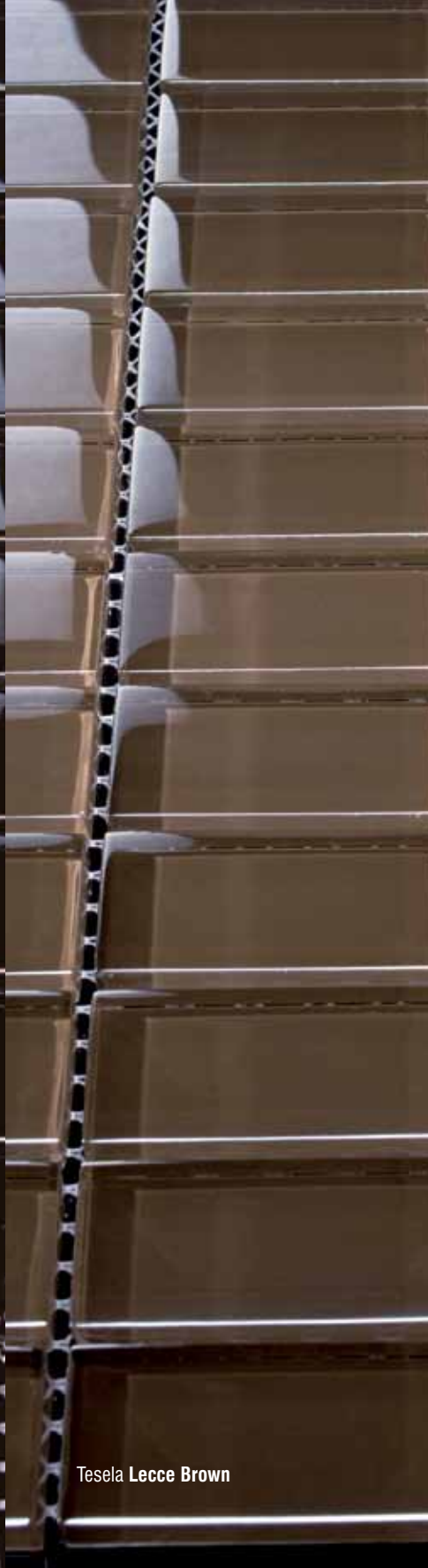

Tesela Lecce Brown



Tesela Lecce White



Tesela Lecce Blue

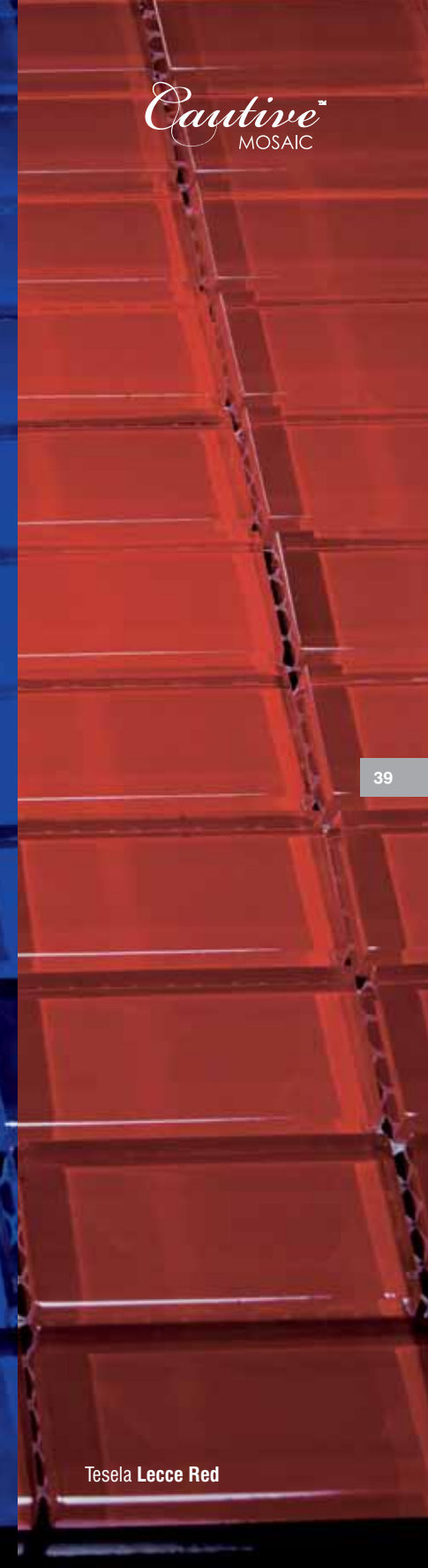

Tesela Lecce Red



CENEFA KUBIC GRIS / NOCE / AZUL
4,8 x 30,4 / 1,9 x 11,9"
 15 x 48 x 8 mm

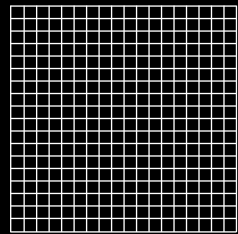

MOSAICO CRISTAL
30,1 x 30,1 / 11,7 x 11,7"
 15 x 15 x 8 mm

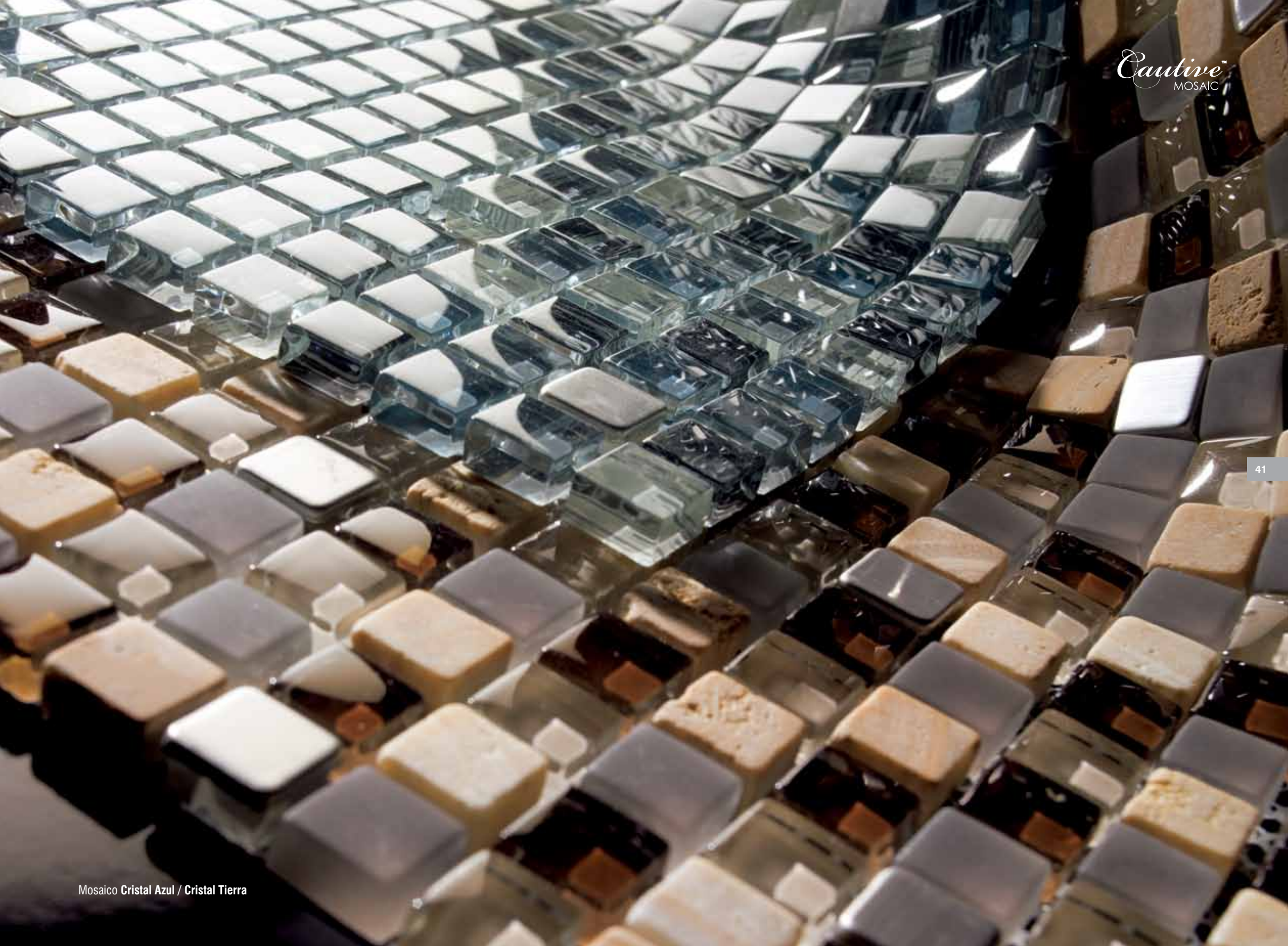

cifre



LISTELO
1,5 x 60 cm / 0,6 x 23,4"
15 x 600 x 8 mm

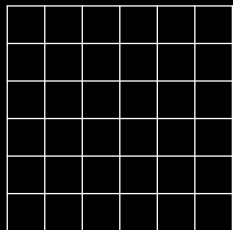

MOSAICO METÁLICO
29,8 x 29,8 cm / 11,6 x 11,6"
48 x 48 x 8 mm

Glass stage

Mosaico Metálico

Listelo Cobre / Plata



Mosaico Catania

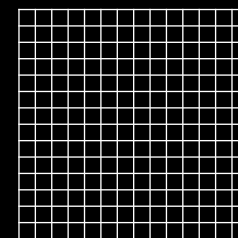

MOSAICO CATANIA
31 x 31 / 12,1 x 12,1"
 20 x 20 x 8 mm

Glass stage

LISTELO
1,5 x 60 cm / 0,6 x 23,4"
15 x 600 x 8 mm

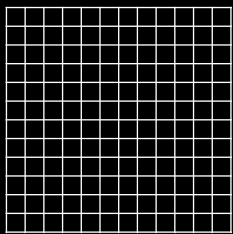

MOSAICO LUBIN MULTICOLOR
30 x 30 cm / 11,7 x 11,7"
 23 x 23 x 8 mm

Glass stage



Mosaico Lubin Orange



Mosaico Lubin Blue





Mosaico Lubin Grey

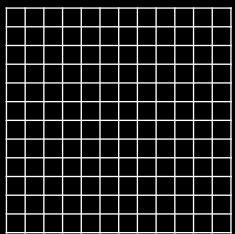

Listelo Cristal Frio / Cristal Naranja

Mosaico Lubin Multicolor



MOSAICO CRAIOVA
30 x 30 cm / 11,7 x 11,7"
 23 x 23 x 8 mm





Captive
MOSAIC

Mosaico Craiova Silver



Mosaico Craiova Golden



Mosaico Aurora Grey



Mosaico Aurora Blue

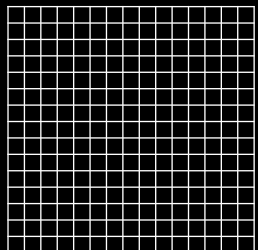

MOSAICO AURORA
32,7 x 32,7 cm / 12,8 x 12,8"
 20 x 20 x 4 mm

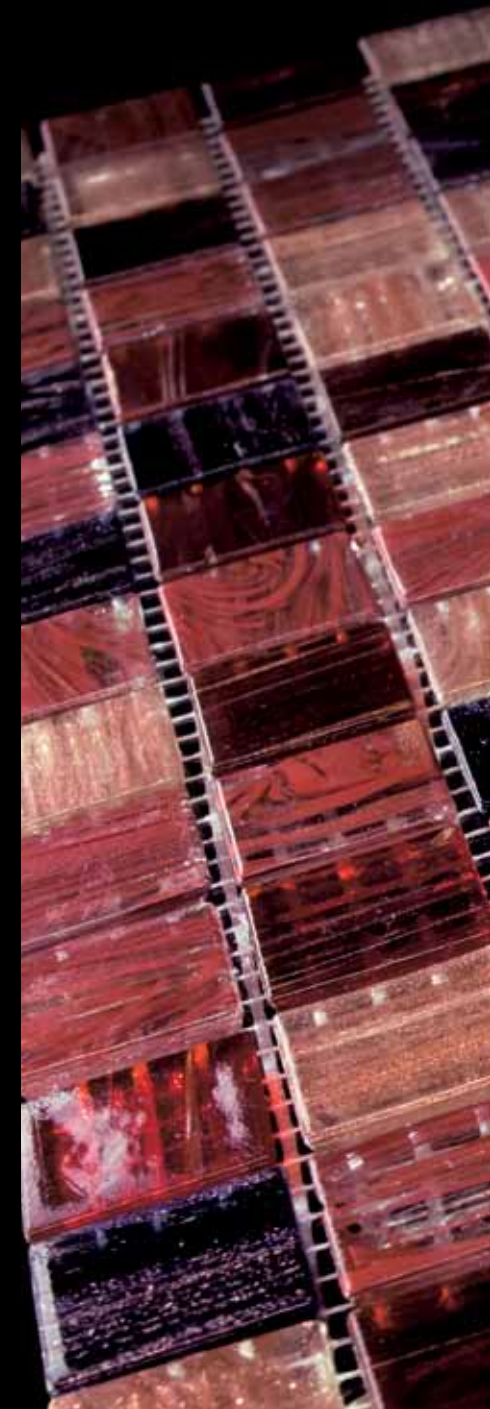

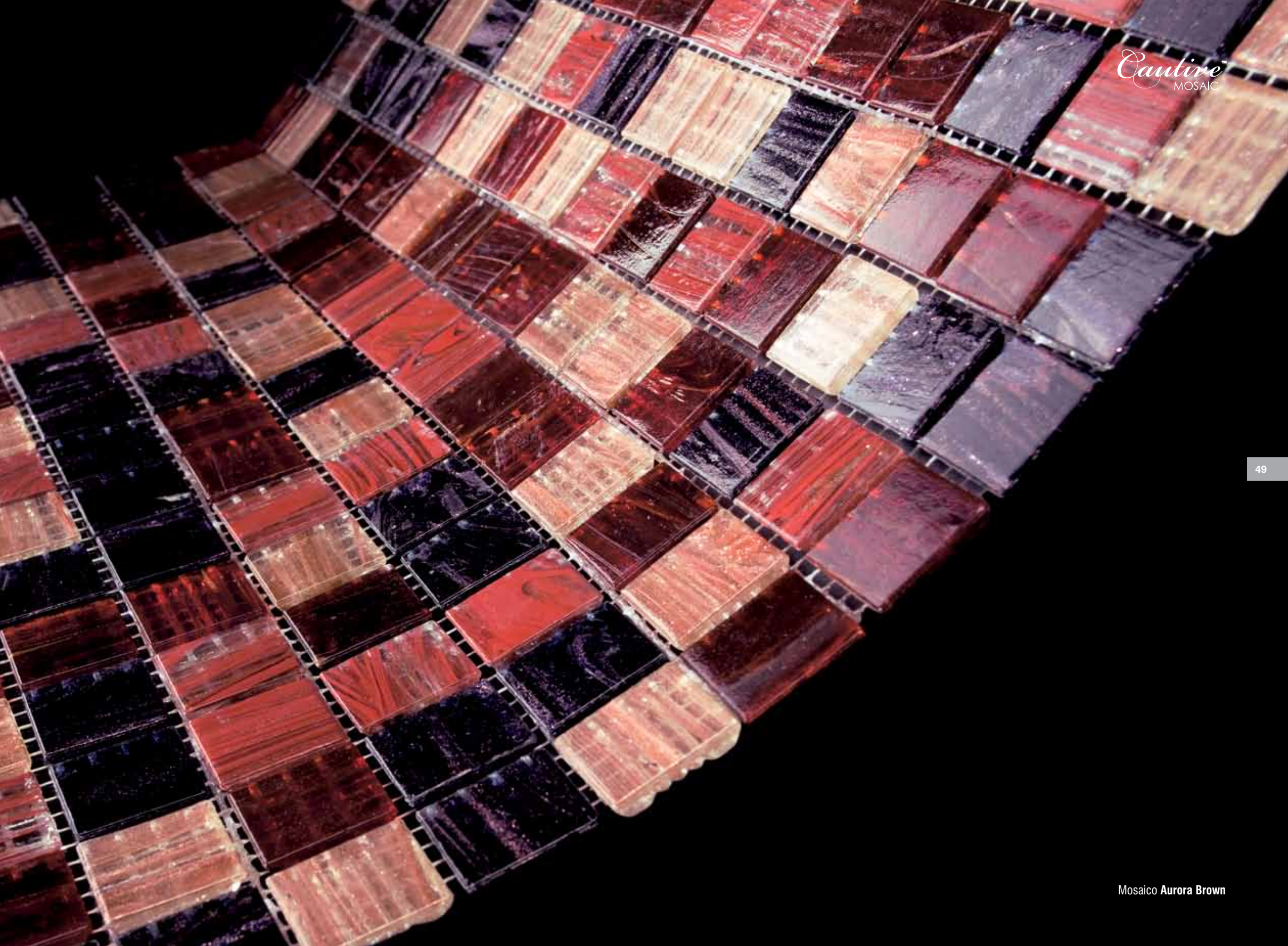

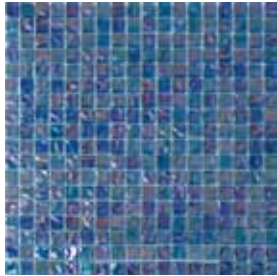

MALLA METALIS BLUE
30,1 x 30,1 cm / 11,8 x 11,8"
SP2050

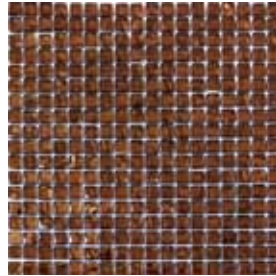

MALLA METALIS BROWN
30,1 x 30,1 cm / 11,8 x 11,8"
SP2050

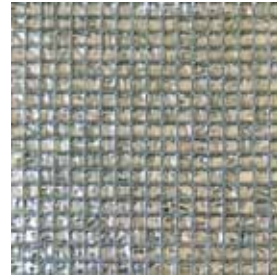

MALLA METALIS WHITE
30,1 x 30,1 cm / 11,8 x 11,8"
SP2050

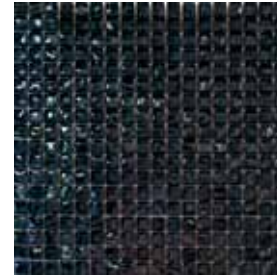

MALLA METALIS DARK
30,1 x 30,1 cm / 11,8 x 11,8"
SP2050

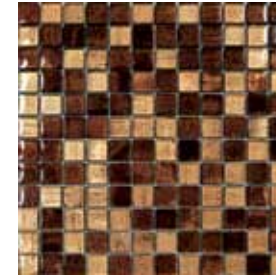

MOSAICO CRAIOVA GOLDEN
30 x 30 cm / 11,7 x 11,7"
SP2050

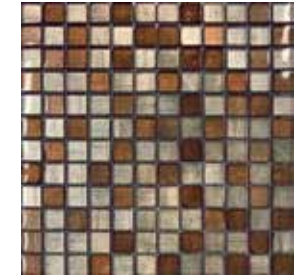

MOSAICO CRAIOVA SILVER
30 x 30 cm / 11,7 x 11,7"
SP2050



TESELA LECCE BLUE
30 x 30 cm / 11,7 x 11,7"
SP2032

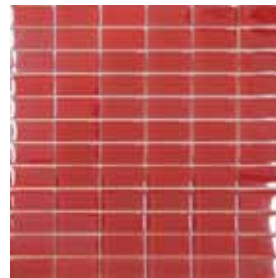

TESELA LECCE RED
30 x 30 cm / 11,7 x 11,7"
SP2032

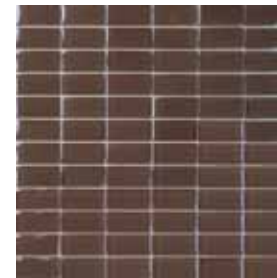

TESELA LECCE BROWN
30 x 30 cm / 11,7 x 11,7"
SP2032



TESELA LECCE WHITE
30 x 30 cm / 11,7 x 11,7"
SP2032



TESELA LECCE BLACK
30 x 30 cm / 11,7 x 11,7"
SP2032

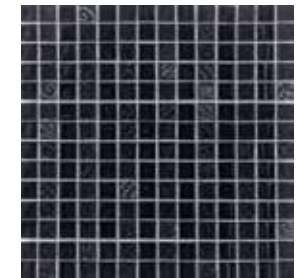

MOSAICO CATANIA
30,5 x 30,5 cm / 11,9 x 11,9"
SP2041



MOSAICO CRISTAL AZUL
30,1 x 30,1 cm / 11,8 x 11,8"
SP2047



MOSAICO CRISTAL TIERRA
30,1 x 30,1 cm / 11,8 x 11,8"
SP2047

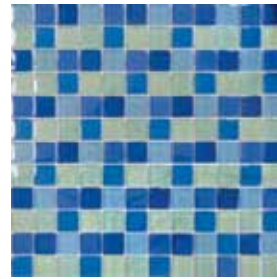

MOSAICO LUBIN BLUE
30 x 30 cm / 11,7 x 11,7"
SP2032

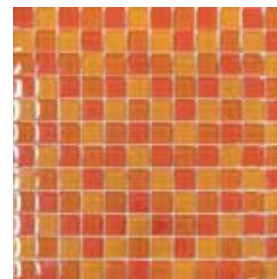

MOSAICO LUBIN ORANGE
30 x 30 cm / 11,7 x 11,7"
SP2032

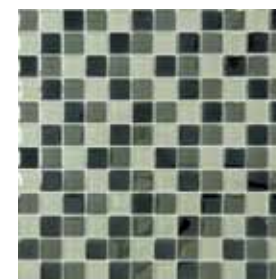

MOSAICO LUBIN GREY
30 x 30 cm / 11,7 x 11,7"
SP2032



MOSAICO LUBIN MULTICOLOR
30 x 30 cm / 11,7 x 11,7"
SP2032

LISTELO COBRE
1,5 x 60 cm / 0,6 x 23,4"
SP2014

LISTELO PLATA
1,5 x 60 cm / 0,6 x 23,4"
SP2014



MOSAICO METÁLICO
29,8 x 29,8 cm / 11,7 x 11,7"
SP2051

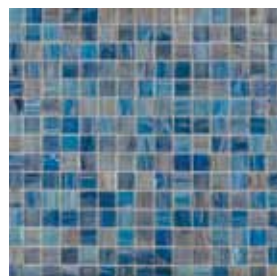

MOSAICO AURORA BLUE
32,7 x 32,7 cm / 12,8 x 12,8"
SP2041

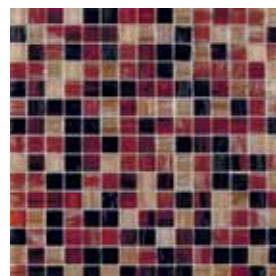

MOSAICO AURORA BROWN
32,7 x 32,7 cm / 12,8 x 12,8"
SP2041



MOSAICO AURORA GREY
32,7 x 32,7 cm / 12,8 x 12,8"
SP2041

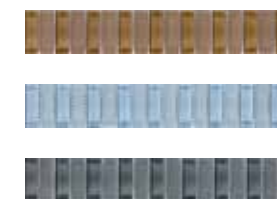

CENEFA KUBIC GRIS/AZUL/NOCE
4,8 x 30,4 cm / 1,8 x 11,9"
SP2012

LISTELO CRISTAL FRIO
1,5 x 60 cm / 0,6 x 23,4"
SP2014

LISTELO CRISTAL NARANJA
1,5 x 60 cm / 0,6 x 23,4"
SP2014

PACKING LIST

DESCRIPCIÓN DESCRIPTION DESCRIPTION	FORMATO SIZE FORMAT	MEDIDA MEASURE MESURE	PZ/CAJA PC/BOX PZ/CAISE	PESO/PZ WEIGHT/PZ POIDS/PZ	PESO/CAJA WEIGHT/BOX POIDS/CAISE
Malla Metalis Blue	30,1x30,1	15x15x8	11	1,38	15,16
Malla Metalis Brown	30,1x30,1	15x15x8	11	1,38	15,16
Malla Metalis White	30,1x30,1	15x15x8	11	1,38	15,16
Malla Metalis Dark	30,1x30,1	15x15x8	11	1,38	15,16
Mosaico Craiova Golden	30x30	23x23x8	11	1,50	16,50
Mosaico Craiova Silver	30x30	23x23x8	11	1,50	16,50
Tesela Lecce Blue	30x30	23x48x8	11	1,50	16,50
Tesela Lecce Red	30x30	23x48x8	11	1,50	16,50
Tesela Lecce Brown	30x30	23x48x8	11	1,50	16,50
Tesela Lecce White	30x30	23x48x8	11	1,50	16,50
Tesela Lecce Black	30x30	23x48x8	11	1,50	16,50
Mosaico Catania	31x31	20x20x8	10	1,48	14,75
Mosaico Cristal Azul	30,1x30,1	15x15x8	11	1,33	14,62
Mosaico Cristal Tierra	30,1x30,1	15x15x8	11	1,33	14,62
Mosaico Lubin Blue	30x30	23x23x8	11	1,46	16,02
Mosaico Lubin Orange	30x30	23x23x8	11	1,46	16,02
Mosaico Lubin Grey	30x30	23x23x8	11	1,46	16,02
Mosaico Lubin Multicolor	30x30	23x23x8	11	1,46	16,02
Mosaico Metalico	29,8x29,8	48x48x8	11	1,65	18,11
Mosaico Aurora Blue	32,7x32,7	20x20x4	20	0,75	14,98
Mosaico Aurora Brown	32,7x32,7	20x20x4	20	0,75	14,98
Mosaico Aurora Grey	32,7x32,7	20x20x4	20	0,75	14,98
Cenefa Kubic Gris, Azul, Noce	4,8x30,4	15x48x8	30	0,25	7,41
Listelo Cobre	1,5x60	15x600x8	40	0,17	6,96
Listelo Plata	1,5x60	15x600x8	20	0,17	3,48
Listelo Cristal Frio	1,5x60	15x600x8	40	0,17	6,96
Listelo Cristal Naranja	1,5x60	15x600x8	20	0,17	3,48

cifre

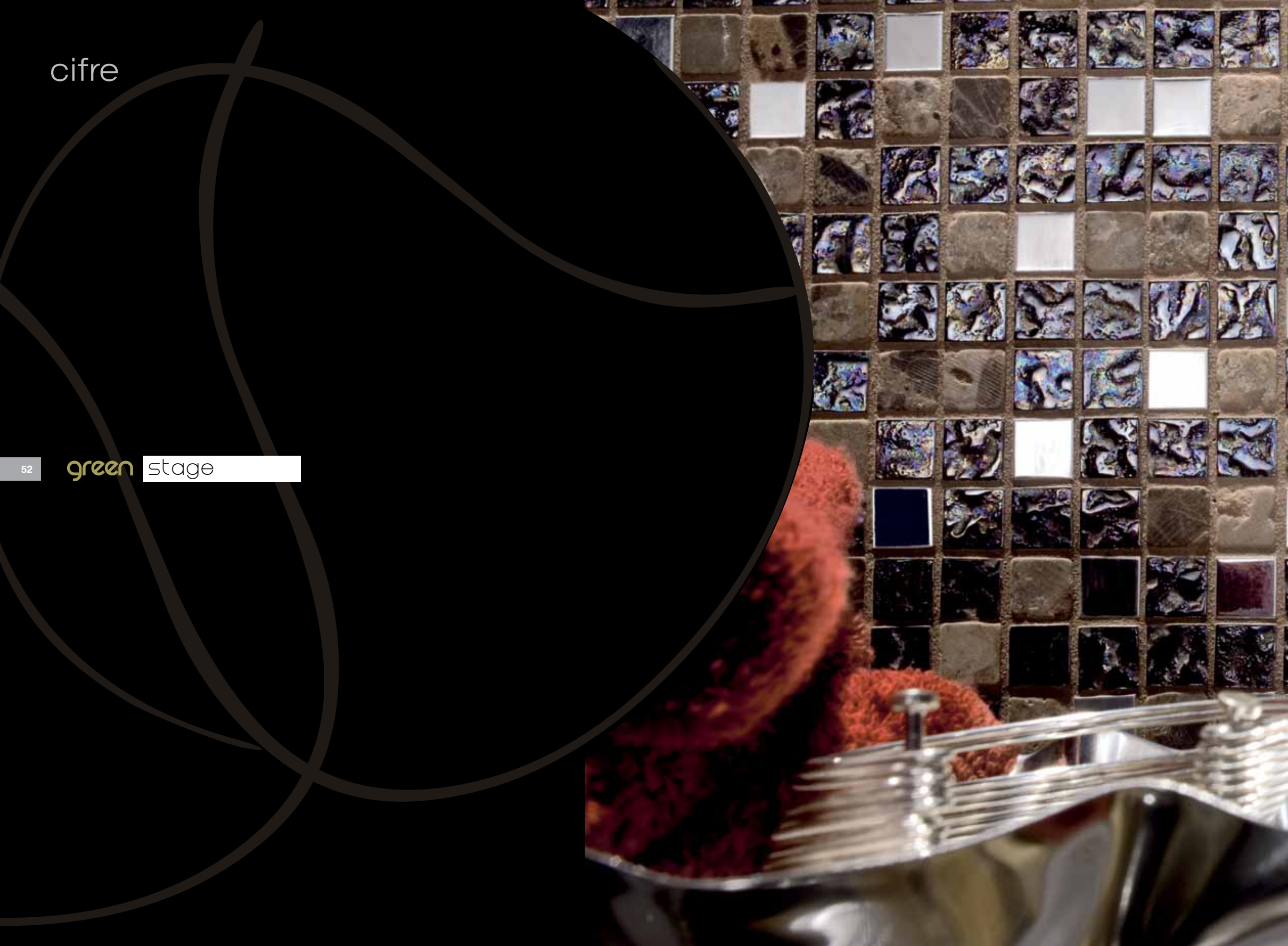

Gel douche et bain
Bath and Shower Gel
200ml e 6.8 fl.oz.

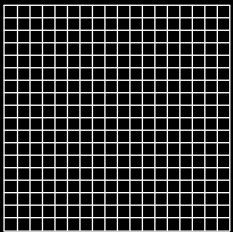
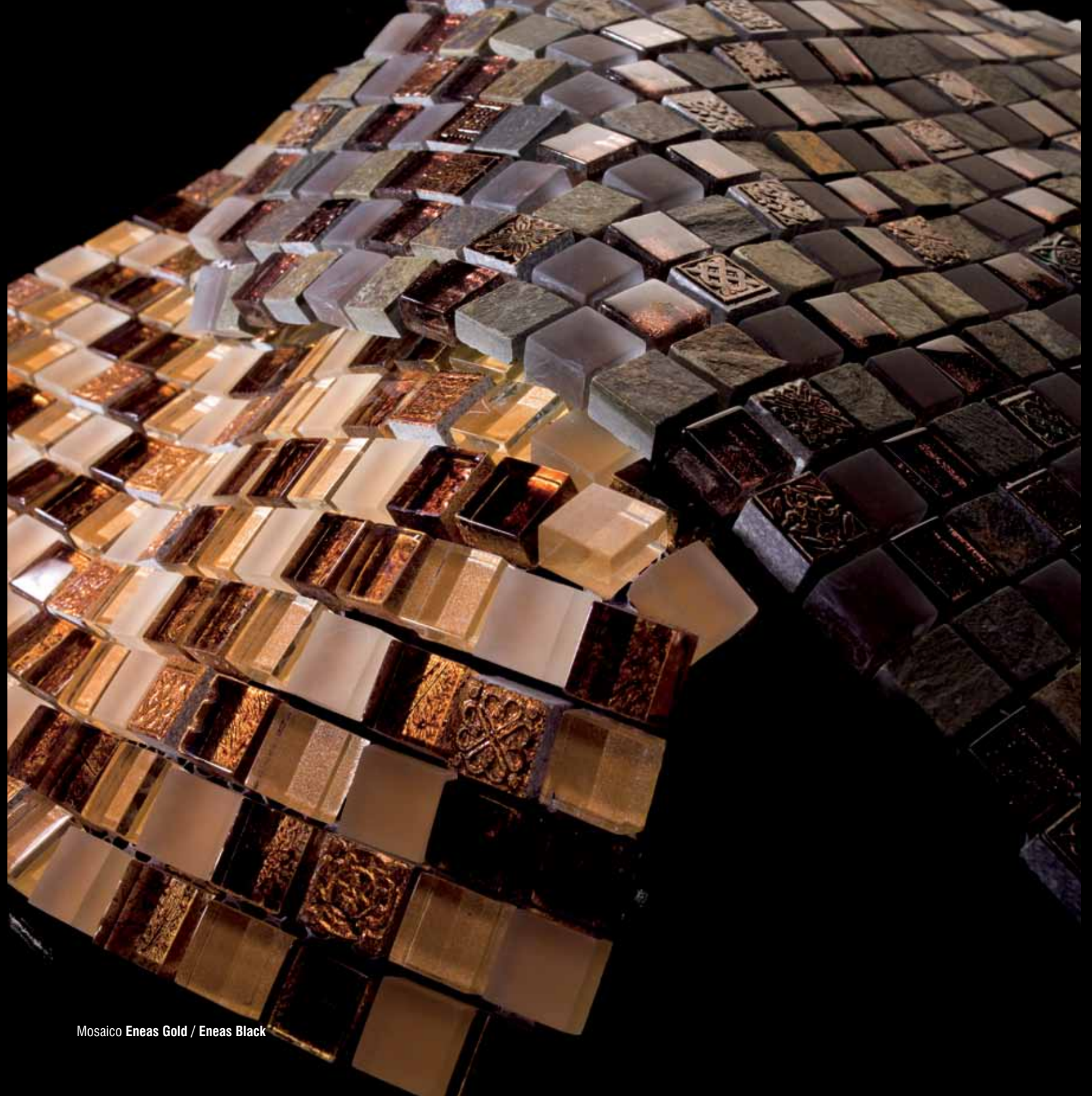

MOSAICO ENEAS
30 x 30 / 11,7 x 11,7"
■ 15 x 15 x 8 mm

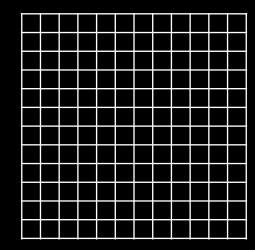
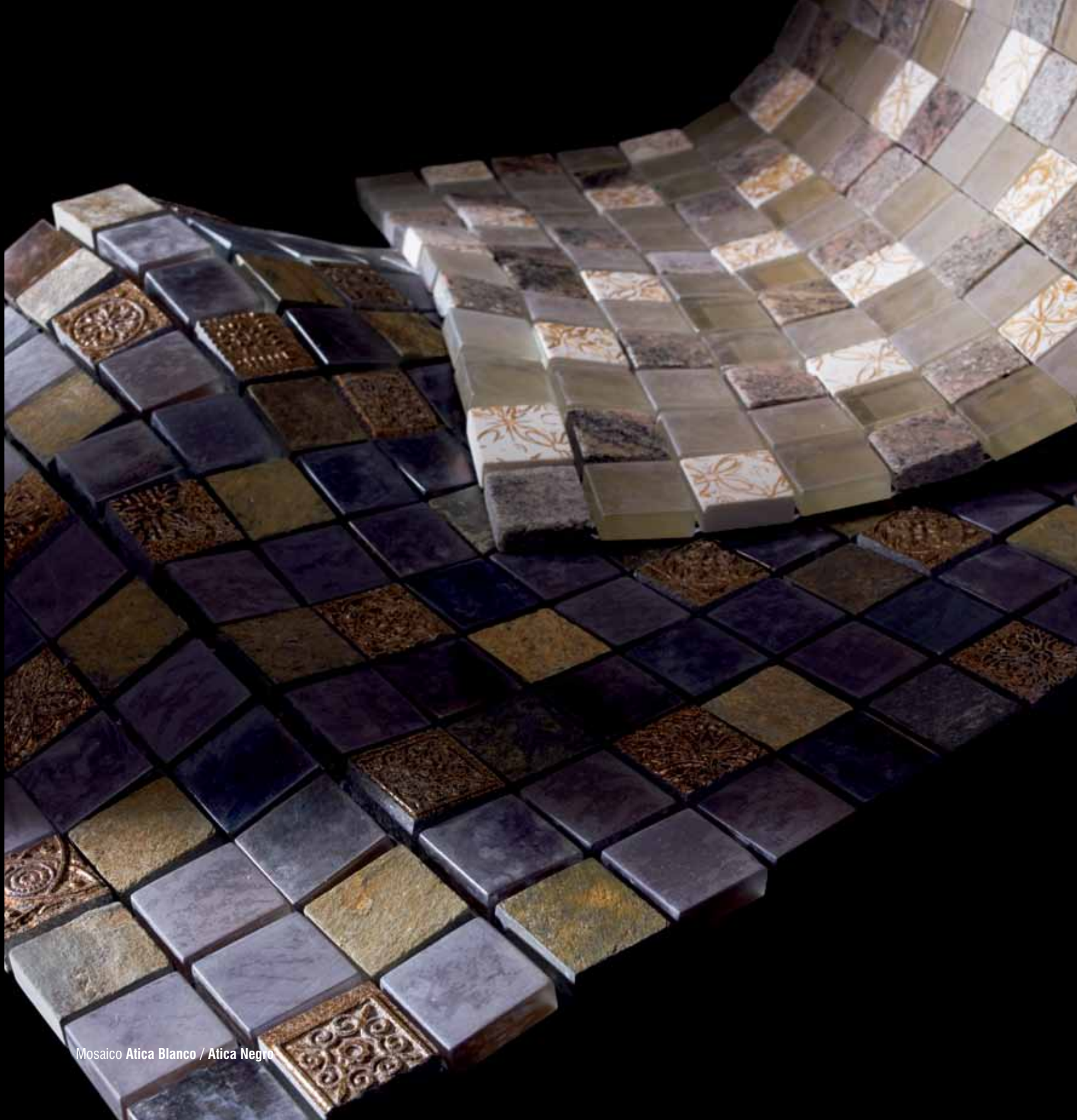

MOSAICO ATICA
30 x 30 / 11,7 x 11,7"
23 x 23 x 8 mm

Mosaico Atica Blanco / Atica Negro

green stage

cifre





Mosaico Pebble White

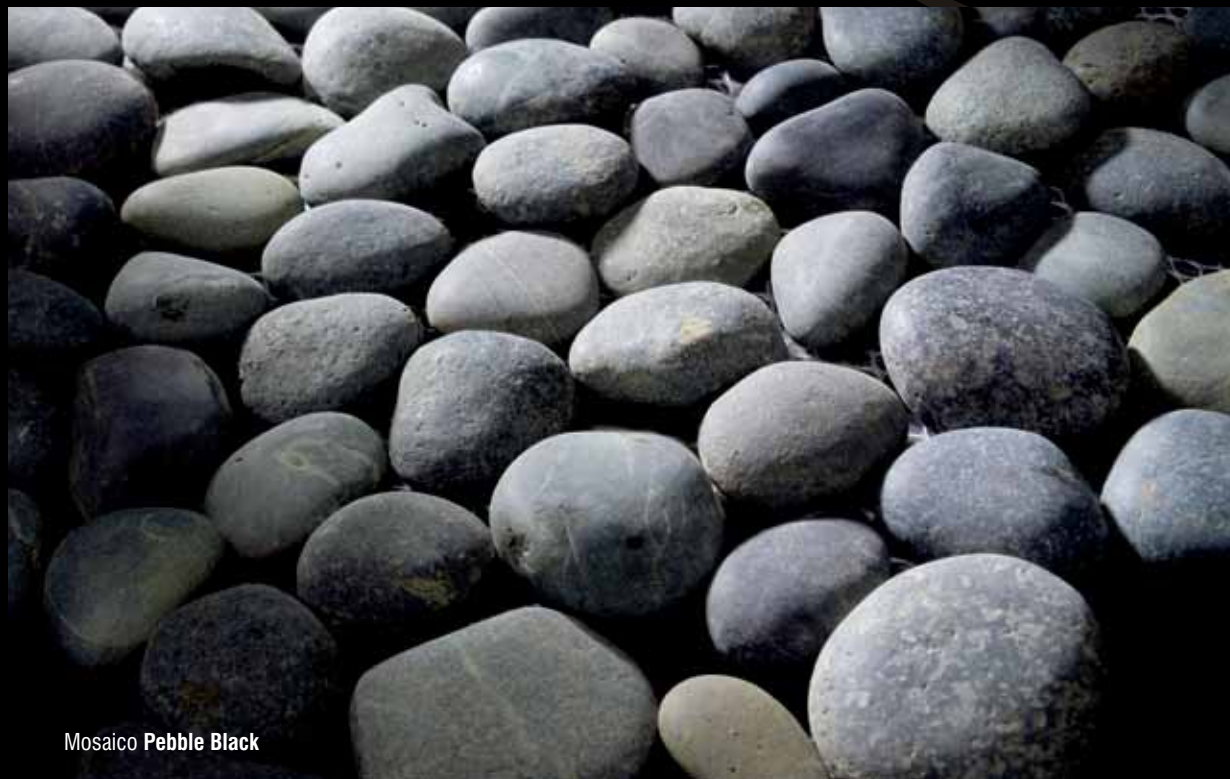

Mosaico Pebble Black

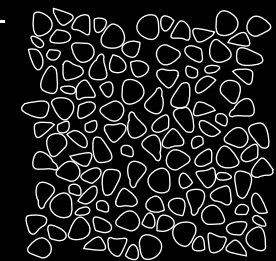

MOSAICO PEBBLE
30,5 x 30,5 / 11,7 x 11,7"

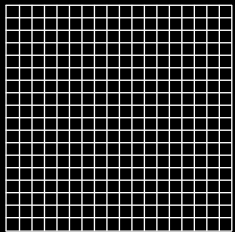

MOSAICO LUCAINA / APULIA /
TRENTINO / CLASSICAL BLACK
30,5 x 30,5 / 11,7 x 11,7"
 15 x 15 x 4 mm

green stage



Mosaico Lucaina



Mosaico Apulia



Mosaico Trentino



Mosaico Classical Black

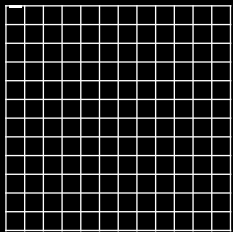

MOSAICO MELIBEA
30 x 30 / 11,7 x 11,7"
 23 x 23 x 8 mm

green stage

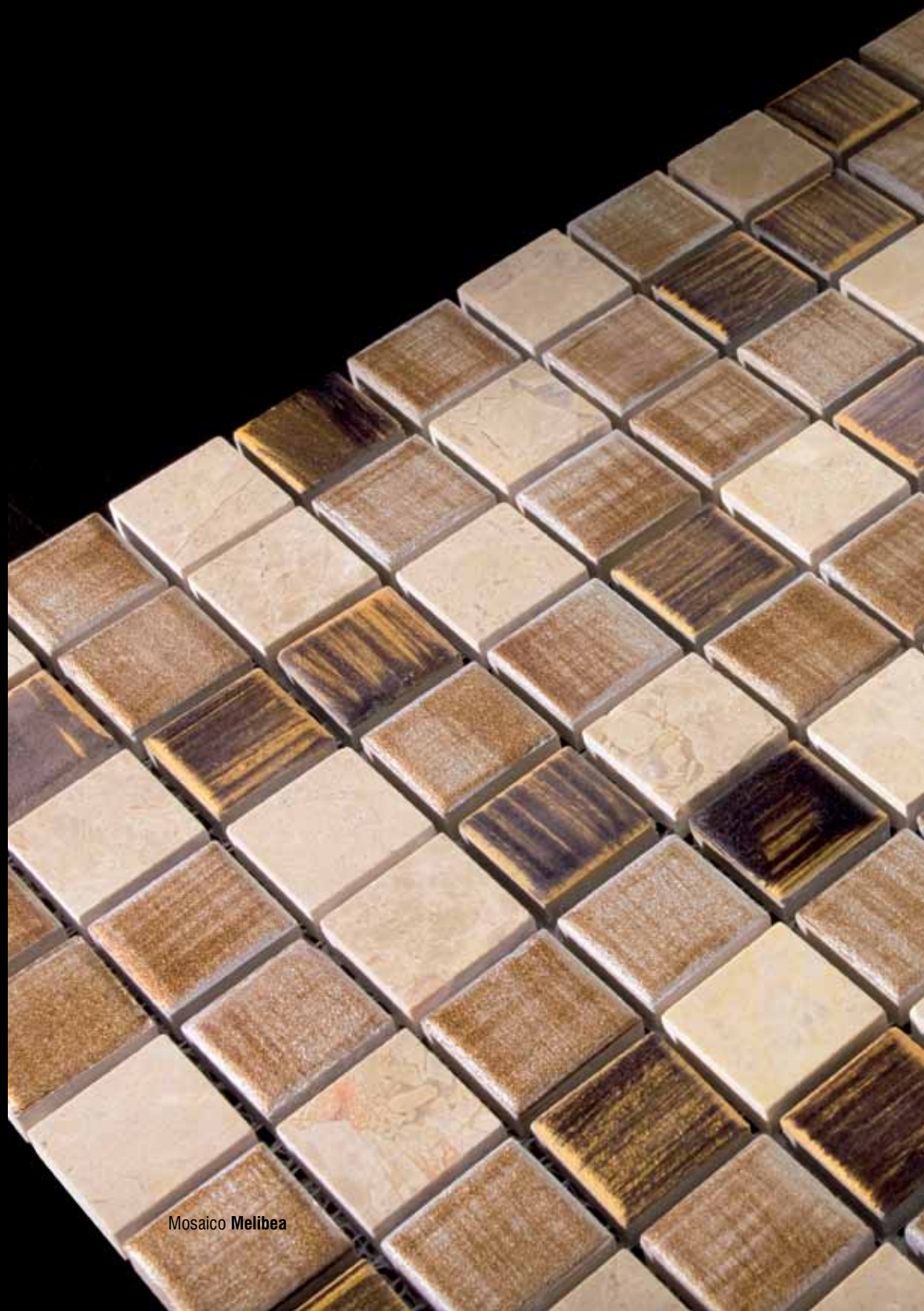

Mosaico Melibea



Mosaico Santorini



Mosaico Dafne

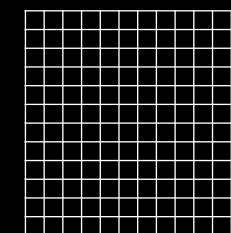

MOSAICO SANTORINI
30 x 30 / 12 x 12"
 23 x 23 x 8 mm

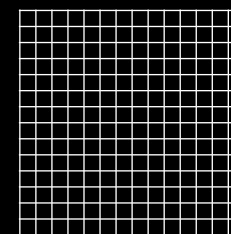

MOSAICO DAFNE
30 x 30 / 11,7 x 11,7"
 20 x 20 x 7 mm



Mosaico Round White



Mosaico Round Black and White

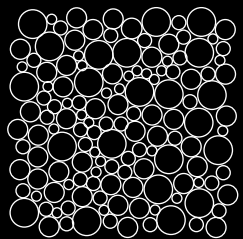

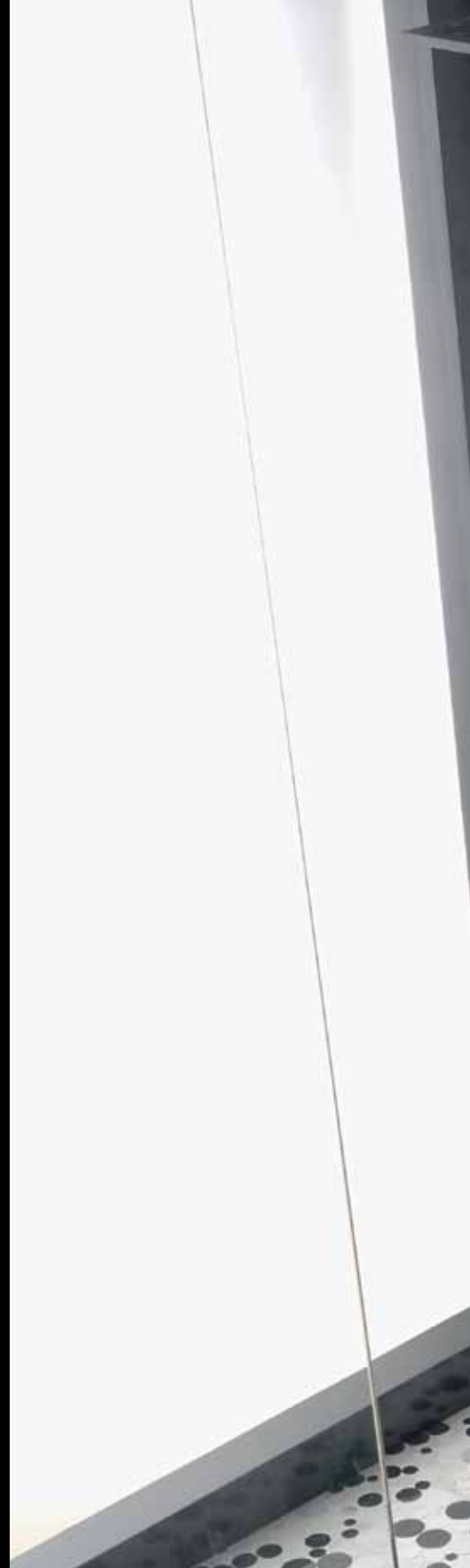

MOSAICO ROUND
30,5 x 30,5 / 11,7 x 11,7"

green stage



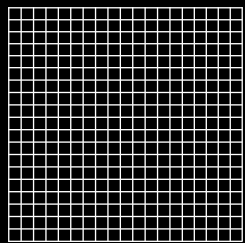



MOSAICO JONICO
31 x 31 / 12,1 x 12,1"
 15 x 15 x 8 mm

green stage



Mosaico Jonico

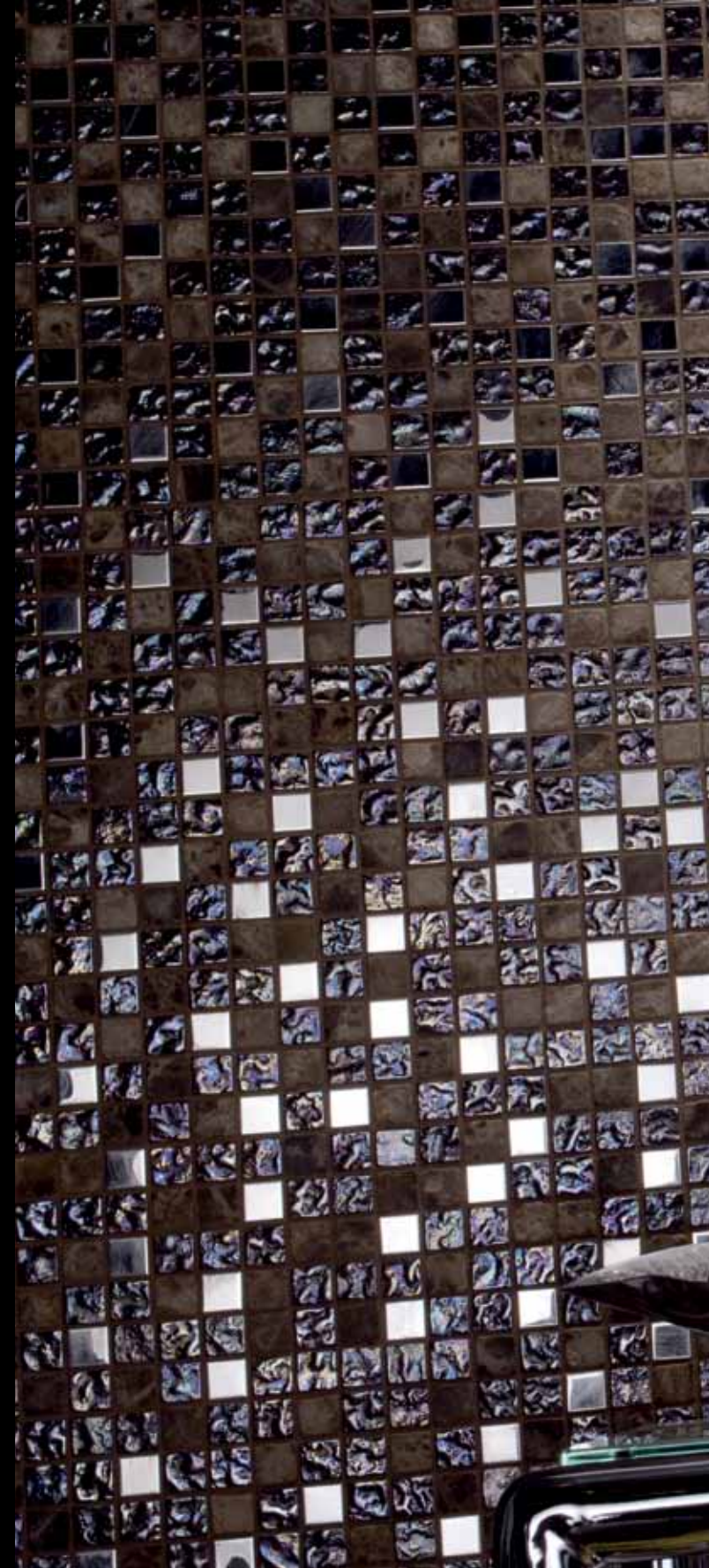



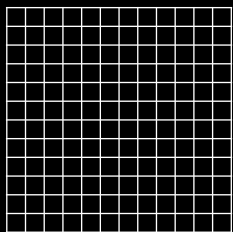

MOSAICO ORADEA
30 x 30 / 11,7 x 11,7"
 23 x 23 x 8 mm

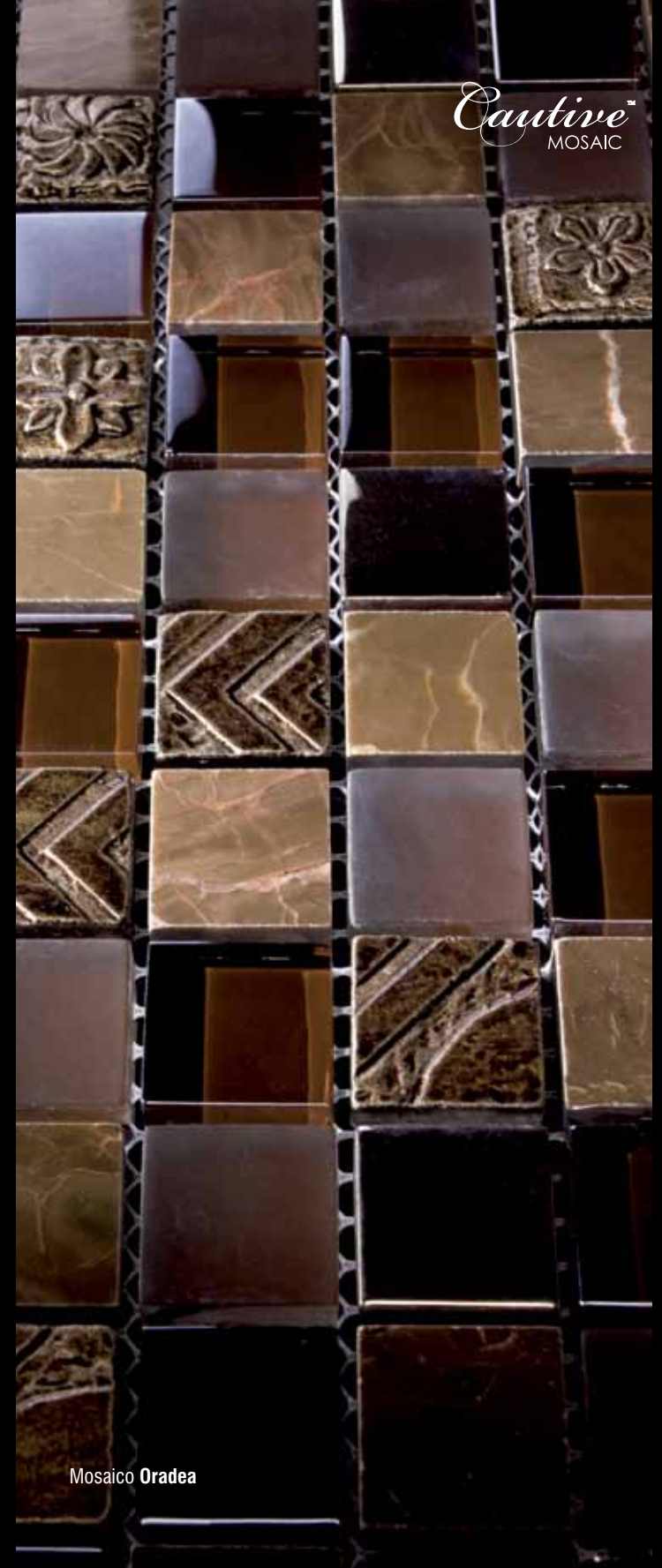

Captive[™]
MOSAIC

Mosaico Oradea

cifre

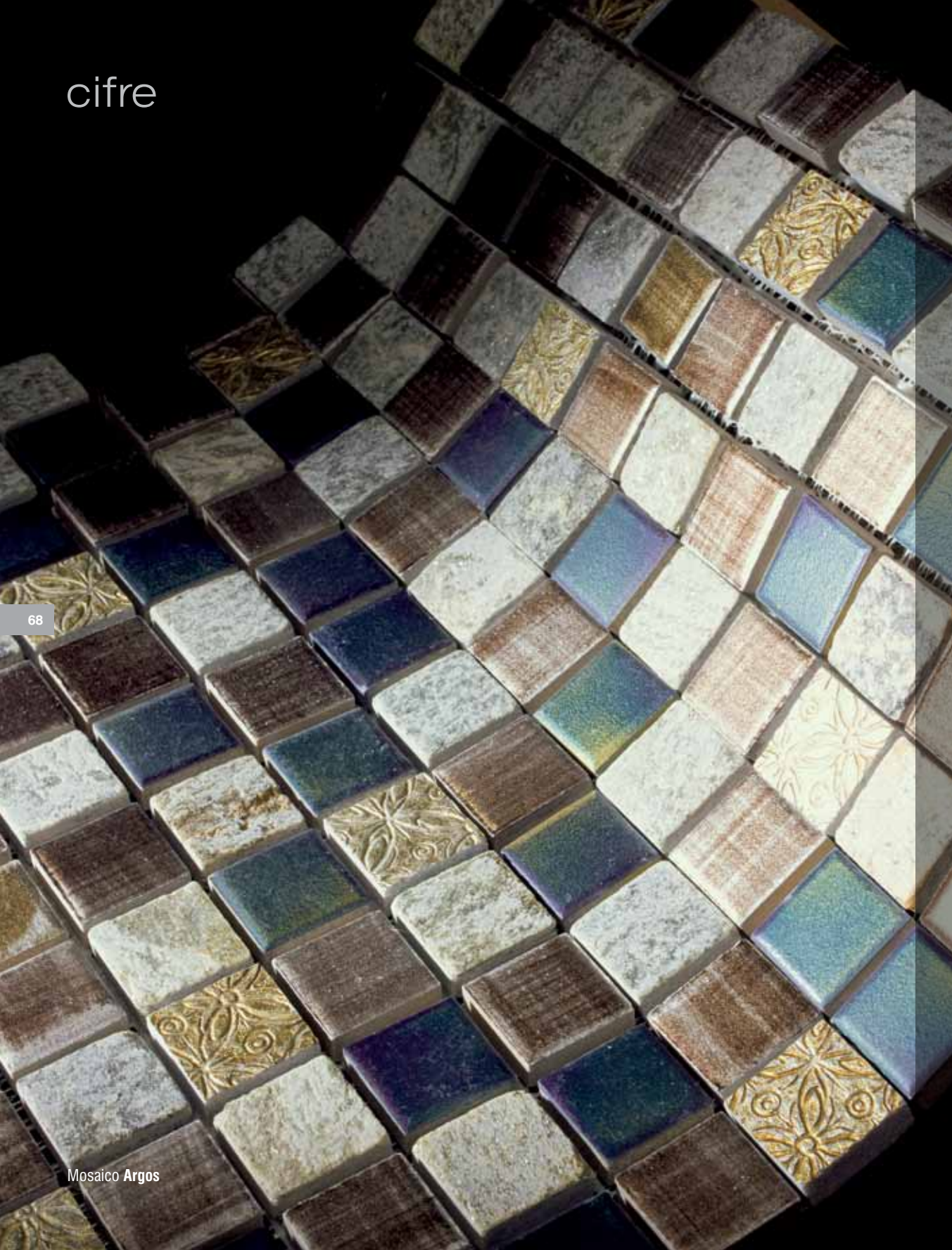

68

Mosaico Argos

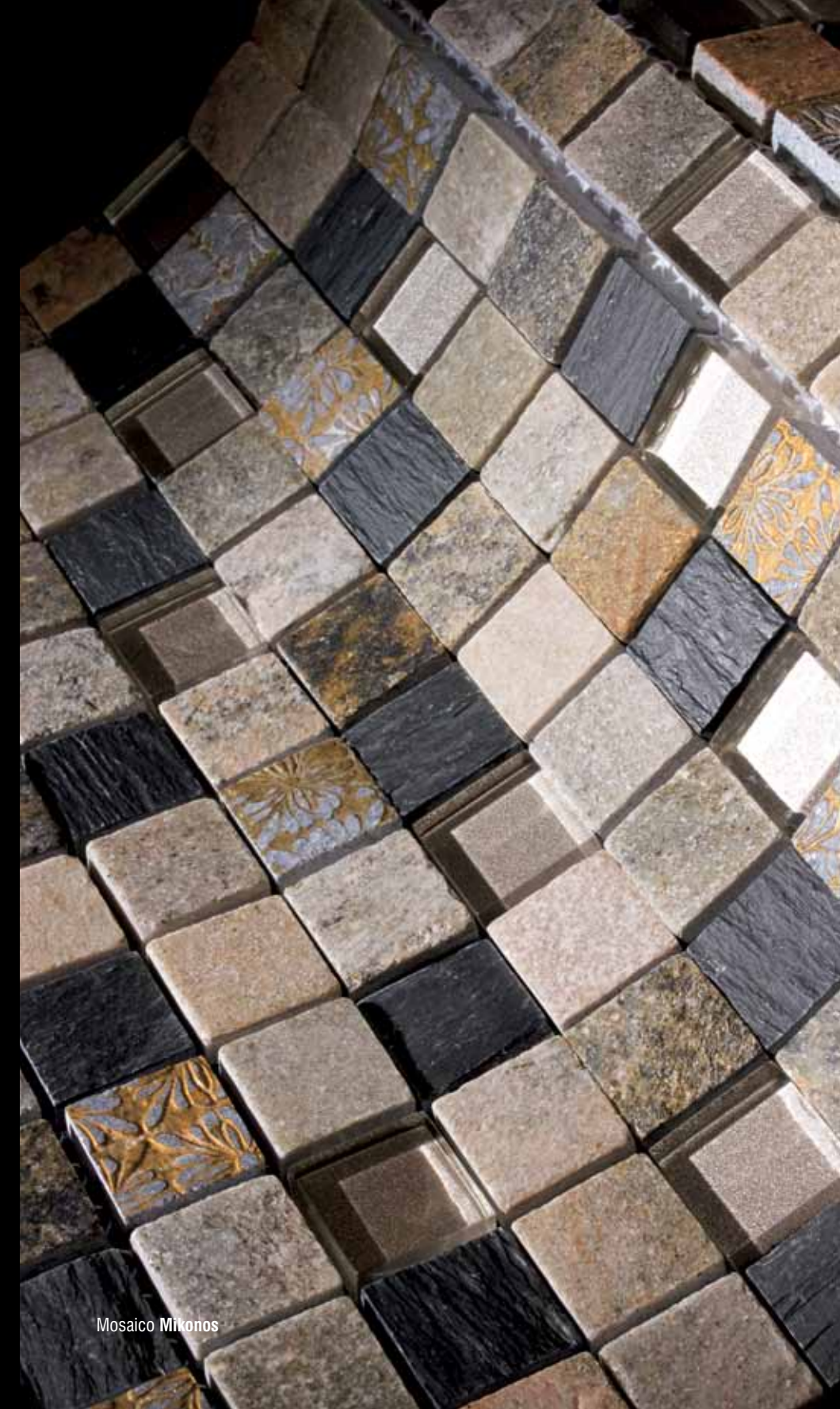

Mosaico Mikonos

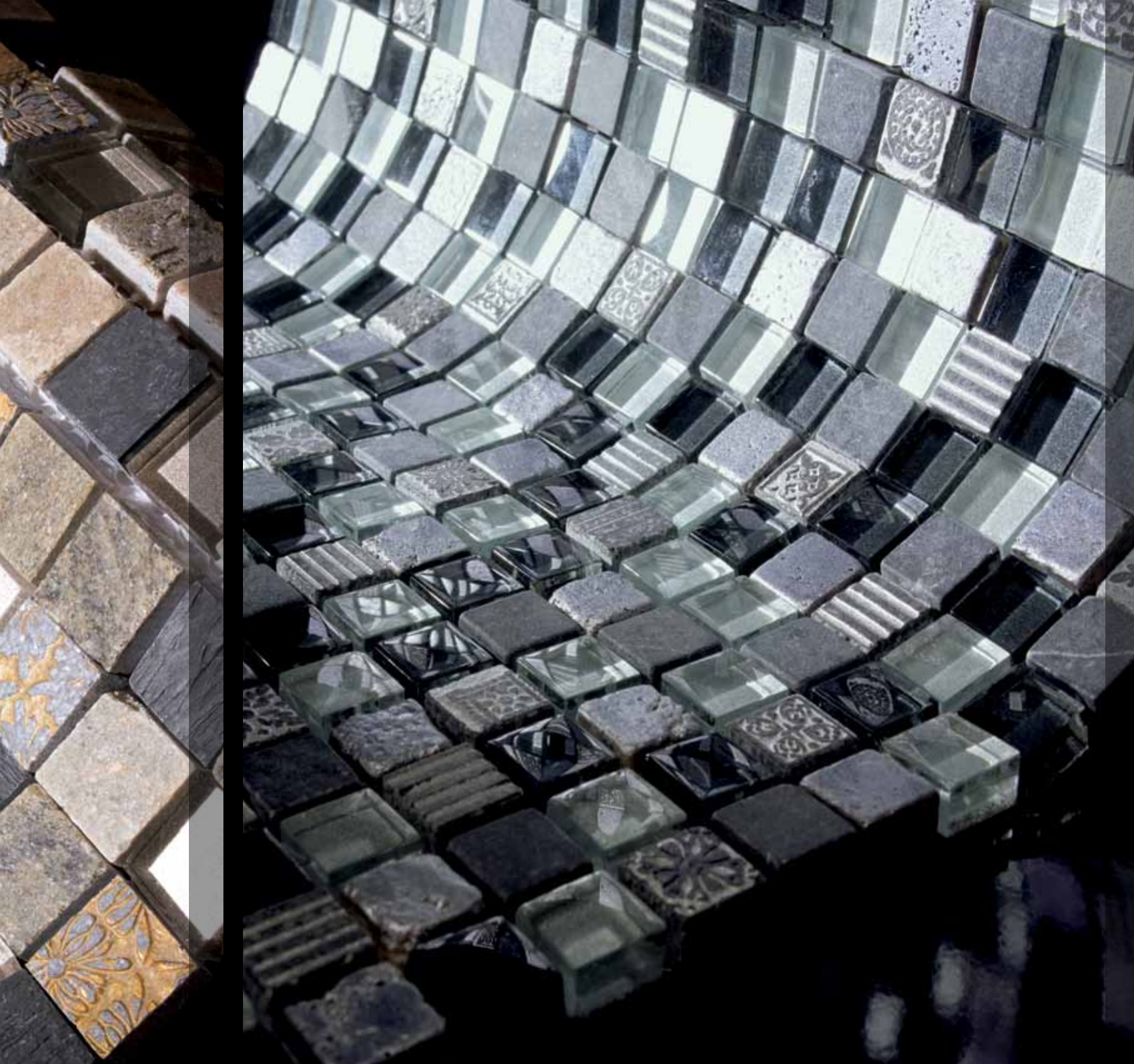

Mosaico Larisa

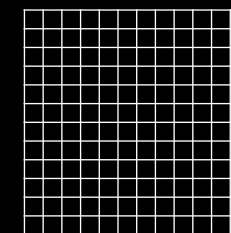

MOSAICO ARGOS
30 x 30 / 11,7 x 11,7"
 23 x 23 x 8 mm

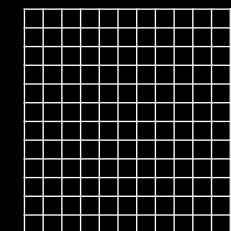

MOSAICO MIKONOS
30 x 30 / 11,7 x 11,7"
 23 x 23 x 8 mm

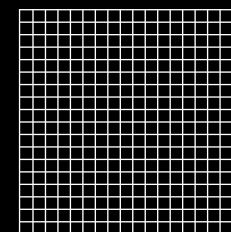

MOSAICO LARISA
30 x 30 / 11,7 x 11,7"
 15 x 15 x 8 mm



CENEFA PIANO
4,8 x 30,4 / 1,9 x 11,9"
15 x 48 x 8 mm

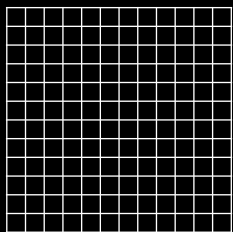

MOSAICO PIRGOS / BURGAS / GORA
30 x 30 / 11,7 x 11,7"
23 x 23 x 8 mm

Mosaico Burgas

Mosaico Pargos

Mosaico Gora



MOSAICO ENEAS GOLD
30 x 30 cm / 11,7 x 11,7"
SP2043

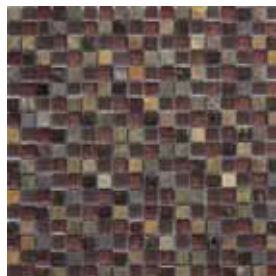

MOSAICO ENEAS BLACK
30 x 30 cm / 11,7 x 11,7"
SP2043



MOSAICO ATICA BLANCO
30 x 30 cm / 11,7 x 11,7"
SP2038

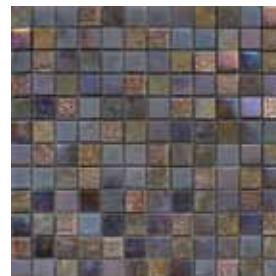

MOSAICO ATICA NEGRO
30 x 30 cm / 11,7 x 11,7"
SP2038



MOSAICO PEBBLE WHITE
30,5 x 30,5 cm / 11,9 x 11,9"
SP2032



MOSAICO PEBBLE BLACK
30,5 x 30,5 cm / 11,9 x 11,9"
SP2032



MOSAICO LUCAINA
30,5 x 30,5 cm / 11,9 x 11,9"
SP2032



MOSAICO APULIA
30,5 x 30,5 cm / 11,9 x 11,9"
SP2032



MOSAICO TRENTO
30,5 x 30,5 cm / 11,9 x 11,9"
SP2032

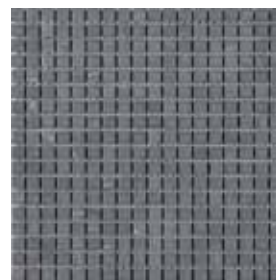

MOSAICO CLASSICAL BLACK
30,5 x 30,5 cm / 11,9 x 11,9"
SP2032

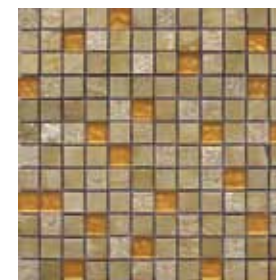

MOSAICO SANTORINI
30 x 30 cm / 11,7 x 11,7"
SP2038



MOSAICO DAFNE
30 x 30 cm / 11,7 x 11,7"
SP2032



MOSAICO ROUND WHITE
30,5 x 30,5 cm / 11,9 x 11,9"
SP2050



MOSAICO ROUND BLACK and WHITE
30,5 x 30,5 cm / 11,9 x 11,9"
SP2050



MOSAICO JONICO
31 x 31 cm / 12,1 x 12,1"
SP2043

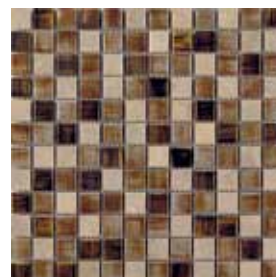

MOSAICO MELIBEA
30 x 30 cm / 11,7 x 11,7"
SP2032



MOSAICO ORADEA
30 x 30 cm / 11,7 x 11,7"
SP2042



MOSAICO ARGOS
30 x 30 cm / 11,7 x 11,7"
SP2032



MOSAICO MIKONOS
30 x 30 cm / 11,7 x 11,7"
SP2032



MOSAICO LARISA
30 x 30 cm / 11,7 x 11,7"
SP2043

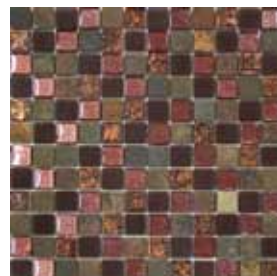

MOSAICO PIRGOS
30 x 30 cm / 11,7 x 11,7"
SP2041



MOSAICO BURGAS
30 x 30 cm / 11,7 x 11,7"
SP2041



MOSAICO GORA
30 x 30 cm / 11,7 x 11,7"
SP2042



CENefa PIANO
4,8 x 30,4 cm / 1,9 x 11,9"
SP2016

PACKING LIST

DESCRIPCIÓN DESCRIPTION DESCRIPTION	FORMATO SIZE FORMAT	MEDIDA MEASURE MESURE	PZ/CAJA PC/BOX PZ/CAISE	PESO/PZ WEIGHT/PZ POIDS/PZ	PESO/CAJA WEIGHT/BOX POIDS/CAISSE
Piano Cenefa	4,8x30,4	15x48x8	30	0,26	7,89
Burgas Mosaico	30x30	23x23x8	11	1,50	16,50
Gora Mosaico	30x30	23x23x8	11	1,50	16,50
Oradea Mosaico	30x30	23x23x8	11	1,50	16,50
Pirgos Mosaico	30x30	23x23x8	11	1,50	16,50
Argos Mosaico	30x30	23x23x8	11	1,50	16,50
Atica Blanco Mosaico	30x30	23x23x8	11	1,50	16,50
Atica Negro Mosaico	30x30	23x23x8	11	1,50	16,50
Dafne Mosaico	30x30	20x20x7	11	1,00	11,00
Eneas Black Mosaico	30x30	15x15x8	11	1,36	14,96
Eneas Gold Mosaico	30x30	15x15x8	11	1,36	14,96
Larisa Mosaico	30x30	15x15x8	11	1,36	14,96
Melibea Mosaico	30x30	23x23x8	11	1,50	16,50
Mikonos Mosaico	30x30	23x23x8	11	1,50	16,50
Santorini Mosaico	30x30	23x23x8	11	1,50	16,50
Jonico Mosaico	310x310	15x15x8	10	1,03	10,40
Pebble Black Mosaico	30,5x30,5	-	10	2,28	22,80
Pebble White Mosaico	30,5x30,5	-	10	2,28	22,80
Round White Mosaico	30,5x30,5	-	5	1,97	9,85
Round White & Black Mosaico	30,5x30,5	-	5	1,97	9,85
Apulia Mosaico	30,5x30,5	15x15x4	20	0,88	17,50
Classical Black Mosaico	30,5x30,5	15x15x4	20	0,88	17,50
Lucaina Mosaico	30,5x30,5	15x15x4	20	0,88	17,50
Trentino Mosaico	30,5x30,5	15x15x4	20	0,88	17,50

RECOMENDACIONES A SEGUIR EN LA COLOCACIÓN

El objetivo de estas instrucciones es garantizar la óptima colocación de las diferentes piezas. Confíe únicamente en profesionales cualificados para llevar a cabo esta tarea.

1- PREPARACIÓN DE LA SUPERFICIE:

Es fundamental que la superficie esté bien preparada, ya que esto puede influir en el resultado y acabados finales. No hay que olvidar:

Eliminar suciedad y restos de polvo, aceites, etc.

- Garantizar la estabilidad del soporte.
- Comprobar que el nivelado de la superficie es el correcto. En el caso de detectar desviaciones superiores a los 3 mm, se recomienda aplicar una capa de regularización con productos específicos y picar las irregularidades salientes.
- Asegurar que la superficie está seca, con un máximo de un 3% de humedad contenida.

2- COLOCACIÓN

Es importante tener en cuenta varios factores antes de comenzar la colocación del material *Captive by Cifre*, como la planificación de las piezas para evitar cortes en el mosaico.

Para colocar el mosaico, recomendamos el uso de adhesivo cementoso de altas prestaciones, especialmente indicado para la colocación de mosaico vítreo y gres porcelánico. Emplearemos una llana dentada y utilizaremos su lado liso para extender el cemento-cola uniformemente sobre el muro y 'peinaremos' entonces el adhesivo con el lado dentado (dentadura mínima de 3 mm). Es importante controlar la superficie sobre la que se aplica el adhesivo, ya que un exceso puede terminar provocando que se reseque el material. Después de colocar la malla, debe presionarse con una llana de goma y asegurar que la distancia entre cada malla es igual a la distancia entre las piezas de una misma malla. Se debe dejar secar el cemento-cola durante 24 horas y posteriormente se procede al rejuntado.

Tratar con cuidado las mallas debido a que pueden contener elementos sensibles al rayado, tales como el cristal, aluminio y pintados a mano.

3- REJUNTADO

Todas las piezas colocadas deben estar completamente limpias y sin restos o residuos de polvo.

El amasado para las juntas se preparará de acuerdo con las instrucciones del fabricante para obtener una mezcla homogénea y cremosa, sin grumos ni burbujas.

Se extiende entonces con la llana de goma y rellenando bien las juntas en toda su profundidad. Con la misma llana retiraremos el exceso de material, mientras que emplearemos una esponja o trapo para retirar los restos del material antes de que fragüe. Es importante realizar esta operación dos veces para garantizar la total limpieza, con 24 horas de tiempo entre la primera y la segunda limpieza.

No se deben utilizar productos abrasivos y alcalinos para eliminar restos de materiales de obra.

4- LIMPIEZA

La limpieza diaria se realizará con limpia cristales y con jabones neutros. Posteriormente se utilizará una bayeta limpia y suave para evitar tanto las rayas como los despuntados. Se recomienda, además, aplicar un reparador o abrillantador de mármol sobre los mosaicos de cristal al menos una vez al año.

5- SERVICIO DE ATENCIÓN A LA COLOCACIÓN

Cifre cuenta con un servicio técnico que presta asesoramiento a los profesionales especializados a la hora de colocar el material. Estamos a su disposición para solventar cualquier duda respecto a la preparación, la colocación o los productos que debe utilizar.

OBSERVACIONES

- En el caso de emplearlo como pavimento, hacerlo únicamente en zonas de poco tránsito por su baja resistencia al rayado y deslizamiento.
- El cristal de *Captive by Cifre* está hecho a mano y, por tanto, son características las pequeñas variaciones en calibre y color. Por eso se recomienda verificar las piezas antes de la colocación.
- En el caso de manipular el vidrio para cortarlo, hay que emplear los materiales especializados concretos.

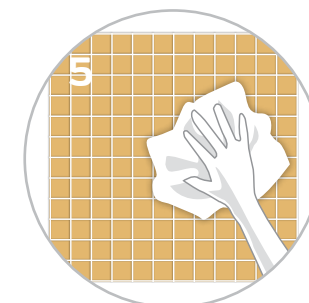
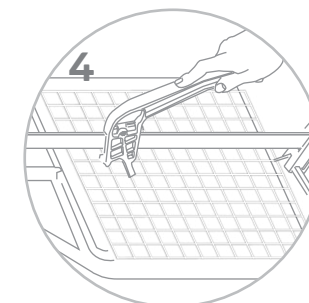
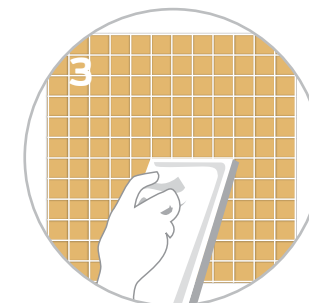
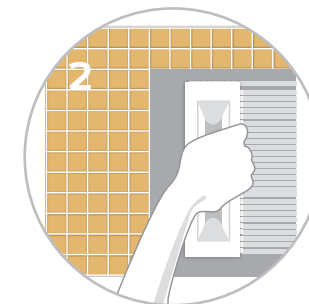

RECOMMENDATIONS FOR LAYING

These instructions are intended to ensure that the various pieces are laid in the best possible way. Entrust this work only to qualified professionals.

1- PREPARING THE SURFACE:

It is essential that surface is well prepared, as this can affect the final result and finish. Do not forget: to eliminate dirt and residues of dust, grease, etc.

- to ensure the base is stable.
- Ensure the surface is perfectly flat. If variations greater than 3 mm are found, it is recommended to apply a levelling coat of the appropriate product and cut back any protrusions.
- Ensure the surface is dry, with a maximum of 3% moisture content.

2- LAYING

It is important to bear several factors in mind before starting to lay Cautive by Cifre, such as planning the pieces so as to avoid having to cut the mosaic.

To lay the mosaic, we recommend the use of high-performance cement-based adhesive, especially suitable for laying vitreous mosaic and porcelain tiles.

With a toothed float, use the straight edge to spread the tile adhesive uniformly over the wall and then “comb” the adhesive with the toothed side (minimum 3 mm teeth). It is important not to apply the adhesive to too large an area at a time, otherwise it may dry out.

After applying the mesh, press it with a rubber float and ensure that the distance between meshes is equal to the distance between pieces in the same mesh. The tile cement must be allowed to dry for 24 hours before grouting.

Treat the meshes carefully due to the fact they can contain sensitive elements to striped, such as crystal, aluminium and hand painted.

3- GROUTING

All the pieces laid must be perfectly clean and free of residues and dust.

The grouting material must be prepared according to the manufacturer's instructions to obtain a smooth, creamy mix, without lumps or air-pockets.

It is then spread over the surface using a rubber float, completely filling the joints. Use the same float to remove excess material, while removing all residues with a sponge or cloth before it sets. It is important to perform this operation twice to ensure perfect cleanliness, leaving 24 hours between the two cleanings.

Abrasive and alkaline products must not be used to remove remains of materials of work

4- CLEANING

Routine cleaning is carried out using glass cleaner or neutral detergents. Then use a clean, soft cloth to avoid scratches and clouding. Furthermore, it is recommended to apply a marble treatment to glass mosaics at least once a year.

5- LAYING HELP LINE

Cifre's technical advice service is ready to help specialised professionals when laying the material. We are available to answer any questions on preparation, laying or the products to be used. Shall we lay this?

NOTES

The material should be used as a floor covering only in areas where there is little traffic, in view of its low resistance to scratching and slipping.

Cautive by Cifre is hand made, and so small variations in thickness and colour are characteristic of it. It is therefore recommended to check the pieces before laying.

In order to cut the glass, specific special equipment must be used**:

- Butech special pliers for small cuts and re-entrants.
- Sigma machine for dry cuts.
- Butech diamond disk machine for whole pieces.
- To make holes, use a water-fed drill with Butech diamond bits.

RECOMMANDATIONS À SUIVRE LORS DE LA POSE

L'objectif de ces instructions est de garantir la pose optimale des différentes pièces. Ne confiez que dans des professionnels qualifiés pour réaliser cette tâche.

1- PRÉPARATION DE LA SURFACE :

Il est fondamental que la surface soit bien préparée, vu que ceci peut influencer le résultat et les finitions. Il ne faut pas oublier :

D'éliminer la saleté et les restes de poussière, d'huiles, etc.

- De garantir la stabilité du support.
- De vérifier que le nivellement de la surface est correct. Si des déviations supérieures à 3 mm sont détectées, il est recommandé d'appliquer une couche de mise à niveau avec des produits spécifiques et retirer les irrégularités saillantes.
- De s'assurer que la surface est sèche, avec un maximum de 3% d'humidité contenue.

2- POSE

Il est important de prendre en considération plusieurs facteurs avant de commencer la pose du matériel Cautive by Cifre, comme la planification des pièces pour éviter des fendillements sur la mosaïque.

Pour poser la mosaïque, nous recommandons d'utiliser un adhésif cimenté de grandes performances, particulièrement indiqué pour la pose de mosaïque vitrée et de grès porcelaineux.

Nous emploierons le côté lisse d'une truelle dentée pour étaler uniformément le ciment-colle sur le mur et nous « peignerons » alors l'adhésif avec le côté denté (dentition minimale de 3 mm). Il est important de contrôler la surface sur laquelle est appliqué l'adhésif, vu qu'un excès peut finir par provoquer le dessèchement du matériel.

Après avoir posé la maille, il faut appuyer avec une truelle en caoutchouc et s'assurer que la distance entre chaque maille est égale à la distance entre les pièces d'une même maille. Il faut laisser sécher le ciment-colle pendant 24 heures puis procéder au rejointoyage.

Traiter des mosaïcs avec attention puisque il y a des éléments sensibles à être rayés, par exemple cristal, aluminium ou pains à main.

3- REJOINTOYAGE

Toutes les pièces placées doivent être entièrement propres et sans restes ou résidus de poussière.

Le gâchage des joints sera préparé conformément aux instructions du fabricant pour obtenir un mélange homogène et crémeux, sans grumeaux ni bulles.

Il est alors étalé avec la truelle en caoutchouc, en remplissant bien les joints dans toute leur profondeur. Avec la même truelle, nous retirerons l'excès de matériel, en employant une éponge ou un chiffon pour retirer les restes de matériel avant la prise. Il est important de réaliser cette opération deux fois pour garantir le nettoyage complet, en laissant 24 heures entre le premier et le second nettoyage.

Ne faire pas usage de produits abrasifs ou alcalins pour éliminer restes de matériaux de construction.

4- NETTOYAGE

Le nettoyage quotidien sera réalisé avec un produit de nettoyage pour vitres et des savons neutres. Ensuite sera utilisée une lavette propre et douce pour éviter aussi bien les rayures que les époinçages. En outre, il est recommandé d'appliquer un réparateur ou polisseur de marbre sur les mosaïques en verre au moins une fois par an.

5- SERVICE D'ASSISTANCE POUR LA POSE

Cifre possède un service technique qui offre une assistance aux professionnels spécialisés au moment de placer le matériel. Nous restons à votre disposition pour résoudre tout doute quant à la préparation, la pose ou aux produits à utiliser.

Nous plaçons ceci ?

OBSERVATIONS

En cas d'emploi comme pavement, il ne faut le faire que dans des zones de faible transit en raison de sa faible résistance aux rayures et au glissement.

Le verre de Cautive by Cifre est fabriqué à la main et, par conséquent, les petites variations de calibre et de couleur sont caractéristiques. C'est pourquoi il est recommandé de vérifier les pièces avant la pose.

En cas de manipulation du verre pour le couper, il faut employer les matériels spécialisés concrets** :

- Tenailles spécifiques Butech pour les petites coupures et époinçages.
- Machine Sigma pour les coupures à sec.
- Machine à disque de diamant Butech pour des pièces entières.
- Pour réaliser des perforations, perceuse avec applicateur d'eau et forets de diamant Butech.



Muretto Negro



*Captive*TM STONE

Imagina lugares elegantes, sobrios, capaces de cautivar por su propia esencia y por su tacto cálidamente fresco.
Los fragmentos de la naturaleza que se unen para crear espacios únicos en los que vivir emociones
y sensaciones, la capacidad de seducción de lo que os ha rodeado toda la vida.

Imagine elegant, sober places, that can captivate through their sheer essence and their warmly refreshing feel.
Fragments of nature that come together to create unique spaces to experience sensations and emotions, to be seduced by what has surrounded you all your life.

Elle imagine des lieux élégants, sobres, capables de captiver par sa propre essence et par son toucher chaudement frais.
Des fragments de la nature qui s'unissent pour créer des espaces uniques pour y vivre des émotions
et des sensations, la capacité de séduction de ce qui vous a entouré toute votre vie.

cifre

78

slate STONE





cifre

80



PIZARRA
30 x 60 / 11,7 x 23,4"

MATERIAL DESTONIFICADO
TONED MATERIAL / MATÉRIEL AVEC DIFFERENTS NUANCES

slate STONE

Pizarra **Cemento**





Pizarra Negra

cifre

82

Muretto Negro





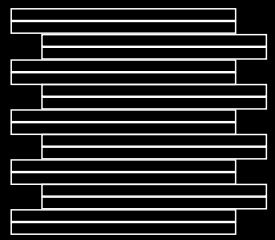

MURETTO
30 x 30 / 11,7 x 11,7"

slate STONE



Muretto Bianco



Muretto Pizarra



Muretto Negro



Muro Blanco

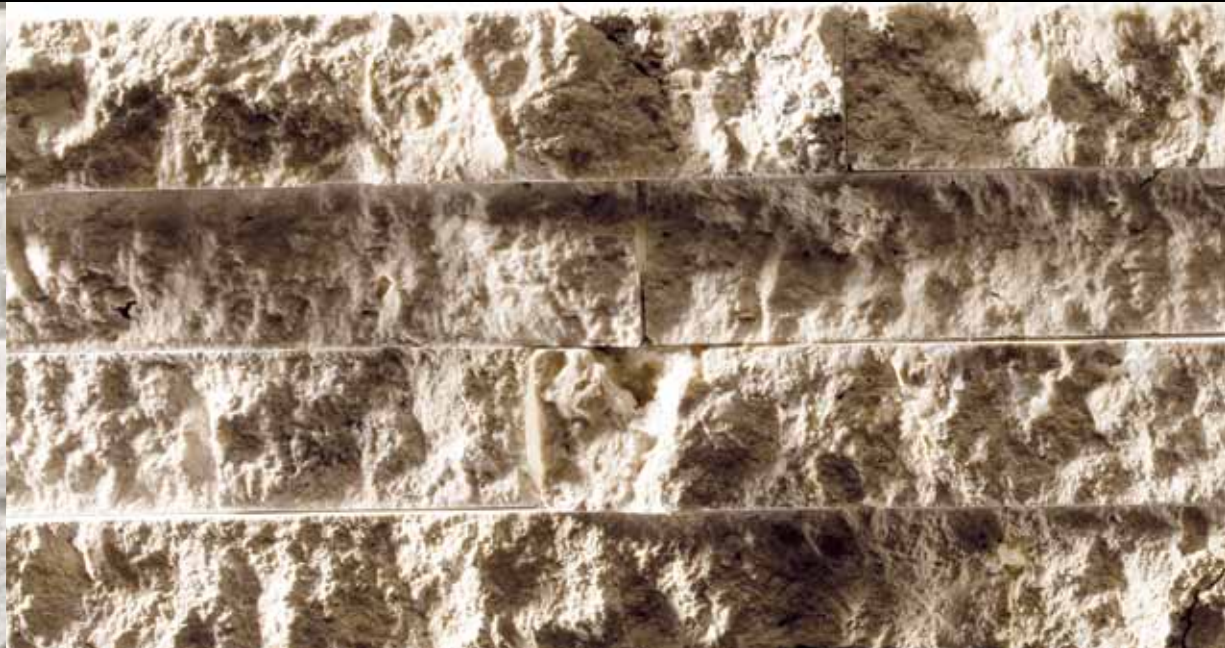

Muro Arena

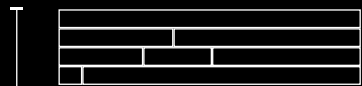

MURO
10 x 40 / 3,9 x 15,6"

slate STONE



Muro Negro



Muro Filos Negro

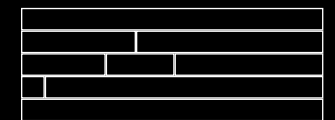

MURO FILOS NEGRO
15 x 40 / 5,9 x 15,6"

slate STONE

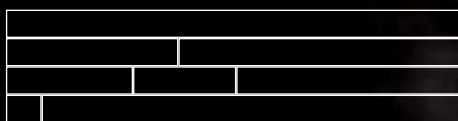

MURO PIEDRA, PIZARRA Y NEGRO
15 x 60 / 5,9 x 23,4"

slate STONE

Muro Piedra

Muro Pizarra

Muro Negro



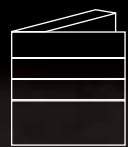

CANTONERA
15 x 15 / 5,9 x 5,9"

slate STONE

Cantonera Muro Negro

Cantonera Muro Pizarra



Cantoneira Muro Piedra



Cantoneira Muro Filos

cifre

92

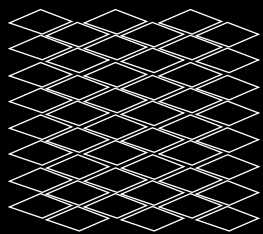

ROMBO PIZARRA
30 x 30 / 11,7 x 11,7"

slate STONE

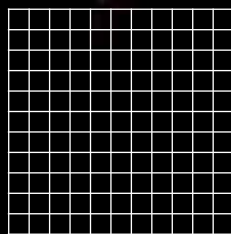

MOSAICO PIZARRA
30 x 30 / 11,7 x 11,7"

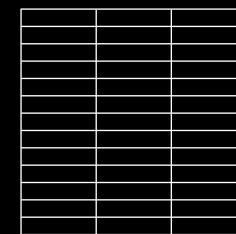

TESELA PIZARRA
30 x 30 / 11,7 x 11,7"

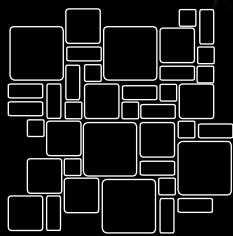
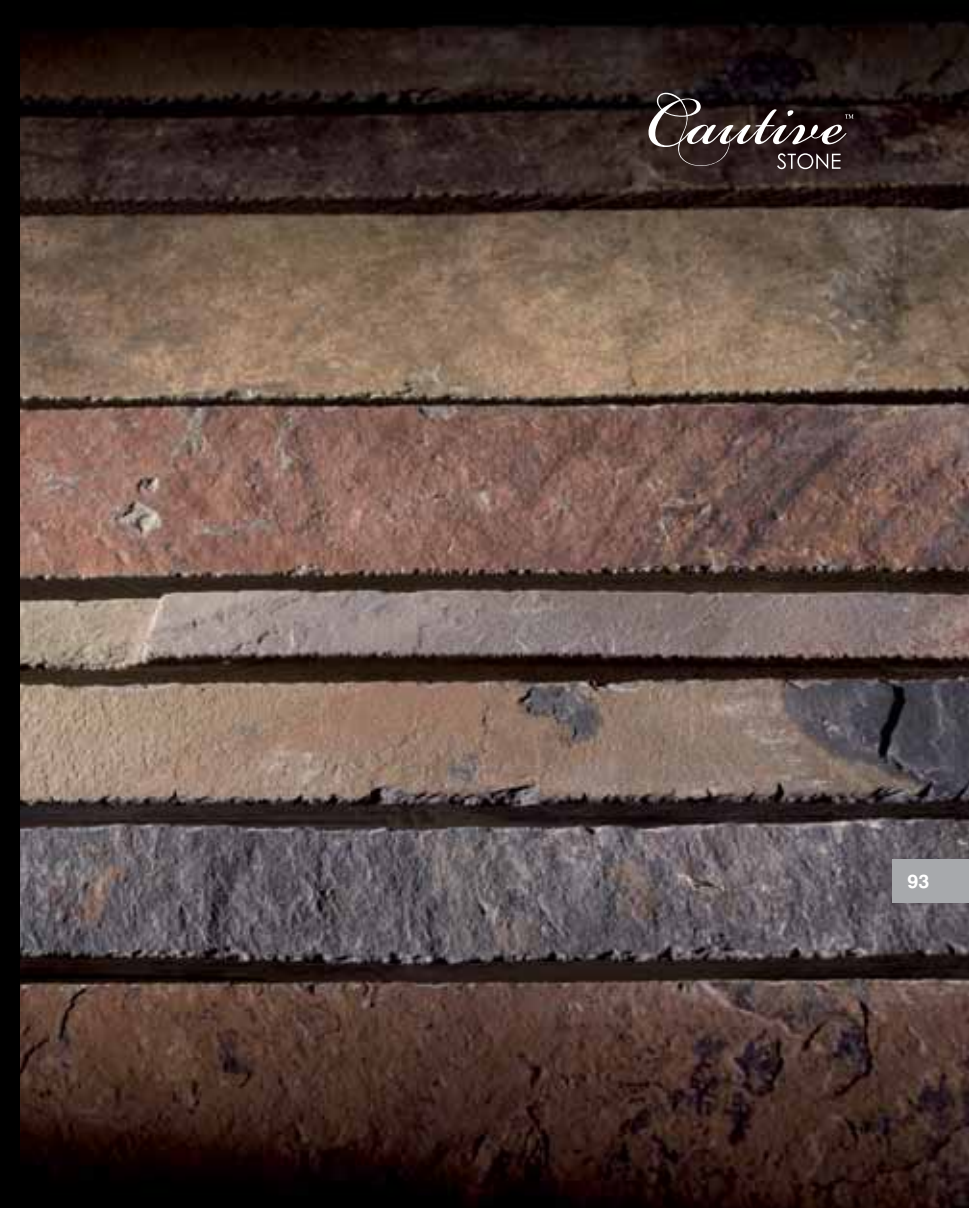

MODULAR PIZARRA
30 x 30 / 11,7 x 11,7"

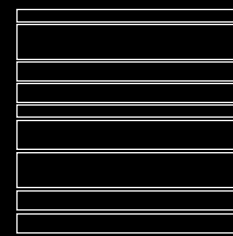

STICK PIZARRA
30 x 30 / 11,7 x 11,7"



PIZARRA CEMENTO
30 x 60 cm / 11,7 x 23,4"
BS1037



PIZARRA NEGRA
30 x 60 cm / 11,7 x 23,4"
BS1037



MURETTO BLANCO
30 x 30 cm / 11,7 x 11,7"
SP2027



MURETTO PIZARRA
30 x 30 cm / 11,7 x 11,7"
SP2027



MURETTO NEGRO
30 x 30 cm / 11,7 x 11,7"
SP2027



MURO PIEDRA
15 x 60 cm / 5,9 x 23,4"
SP2027



MURO PIZARRA
15 x 60 cm / 5,9 x 23,4"
SP2027



MURO NEGRO
15 x 60 cm / 5,9 x 23,4"
SP2027



MURO BLANCO
10 x 40 cm / 3,9 x 15,6"
SP2020



MURO ARENA
10 x 40 cm / 3,9 x 15,6"
SP2020



MURO NEGRO
10 x 40 cm / 3,9 x 15,6"
SP2020



MURO FILOS NEGRO
15 x 40 cm / 5,9 x 15,6"
SP2024



CANTONERA MURO PIEDRA
15 x 15 cm / 5,9 x 5,9"
SP2027



CANTONERA MURO PIZARRA
15 x 15 cm / 5,9 x 5,9"
SP2027



CANTONERA MURO NEGRO
15 x 15 cm / 5,9 x 5,9"
SP2027



CANTONERA MURO FILOS
15 x 15 cm / 5,9 x 5,9"
SP2034



MOSAICO PIZARRA
30 x 30 cm / 11,7 x 11,7"
SP2024



TESELA PIZARRA
30 x 30 cm / 11,7 x 11,7"
SP2032

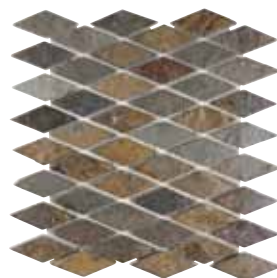

ROMBO PIZARRA
30 x 30 cm / 11,7 x 11,7"
SP2024



MODULAR PIZARRA
30 x 30 cm / 11,7 x 11,7"
SP2024

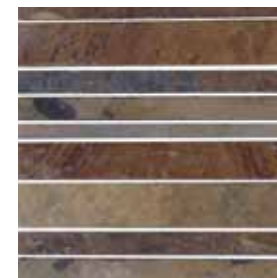

STICK PIZARRA
30 x 30 cm / 11,7 x 11,7"
SP2024

PACKING LIST

DESCRIPCIÓN DESCRIPTION DESCRIPTION	FORMATO SIZE FORMAT	MEDIDA MEASURE MESURE	PZ/CAJA PC/BOX PZ/CAISE	PESO/PZ WEIGHT/PZ POIDS/PZ	PESO/CAJA WEIGHT/BOX POIDS/CAISSE	M2/CAJA M2/BOX M2/CAISE
Pizarra Cemento	30x60	-	5	6,6	33,5	0,9
Pizarra Negra	30x60	-	5	6,6	33,5	0,9
Muretto Blanco	30x30	-	5	2,22	11,28	
Muretto Pizarra	30x30	-	5	2,22	11,28	
Muretto Negro	30x30	-	5	2,22	11,28	
Muro Blanco	10x40	-	8	2,08	16,64	
Muro Arena	10x40	-	8	2,08	16,64	
Muro Negro	10x40	-	8	2,08	16,64	
Muro Filos	15x40	-	5	2,5	12,5	
Cantonera Muro Piedra	15x15	-	4	3	12,17	
Cantonera Muro Pizarra	15x15	-	4	3	12,17	
Cantonera Muro Negro	15x15	-	4	3	12,17	
Cantonera Muro Filos	15x15	-	4	3	12,17	
Muro Piedra	15x60	-	4	6	24	
Muro Pizarra	15x60	-	4	6	24	
Muro Negro	15x60	-	4	6	24	
Mosaico Pizarra	30x30	-	5	2,47	12,52	
Tesela Pizarra	30x30	-	5	2,47	12,52	
Rombo Pizarra	30x30	-	5	2,47	12,52	
Modular Pizarra	30x30	-	5	2,47	12,52	
Stick Pizarra	30x30	-	5	2,47	12,52	

cifre

96

ceramic STONE

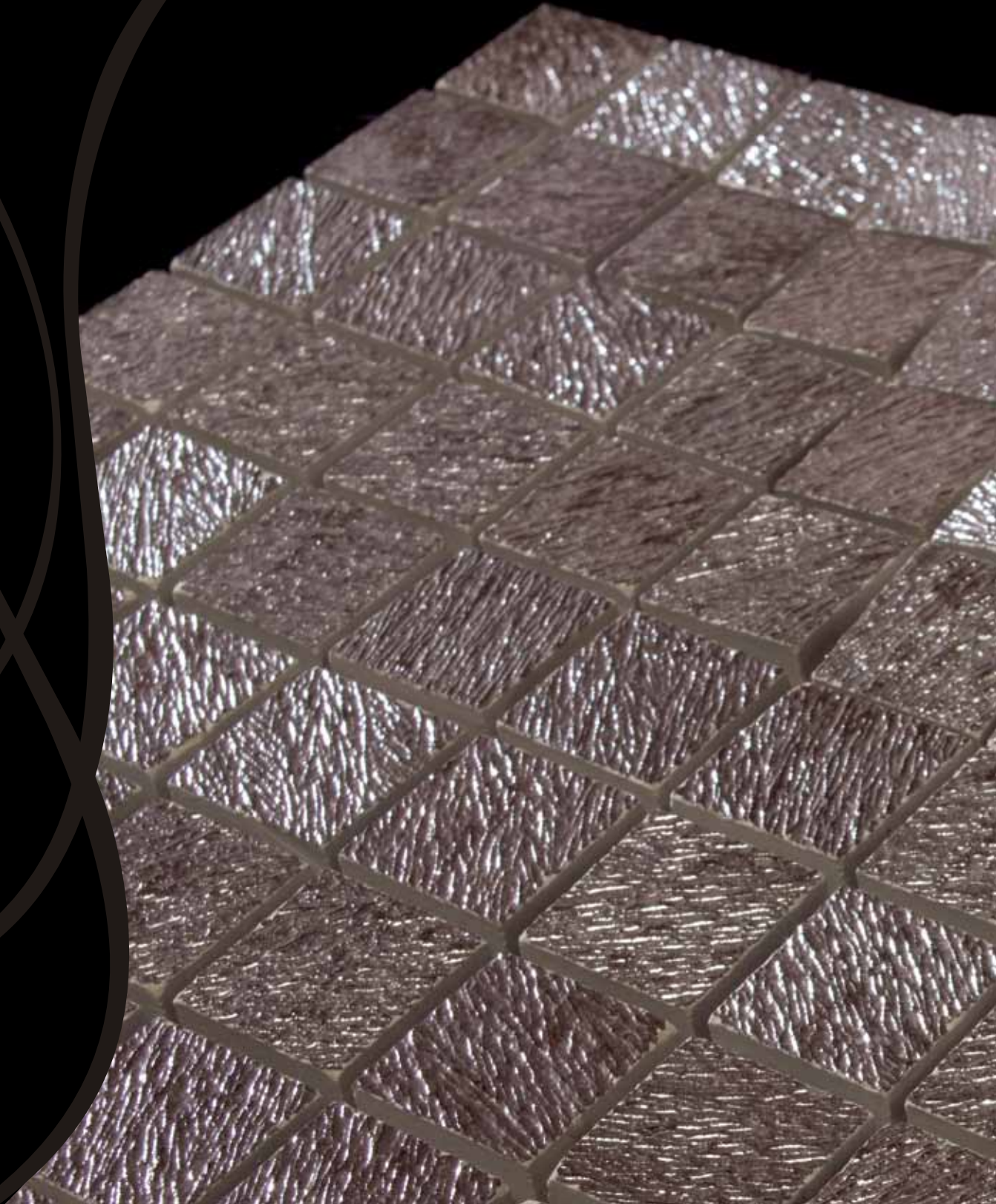

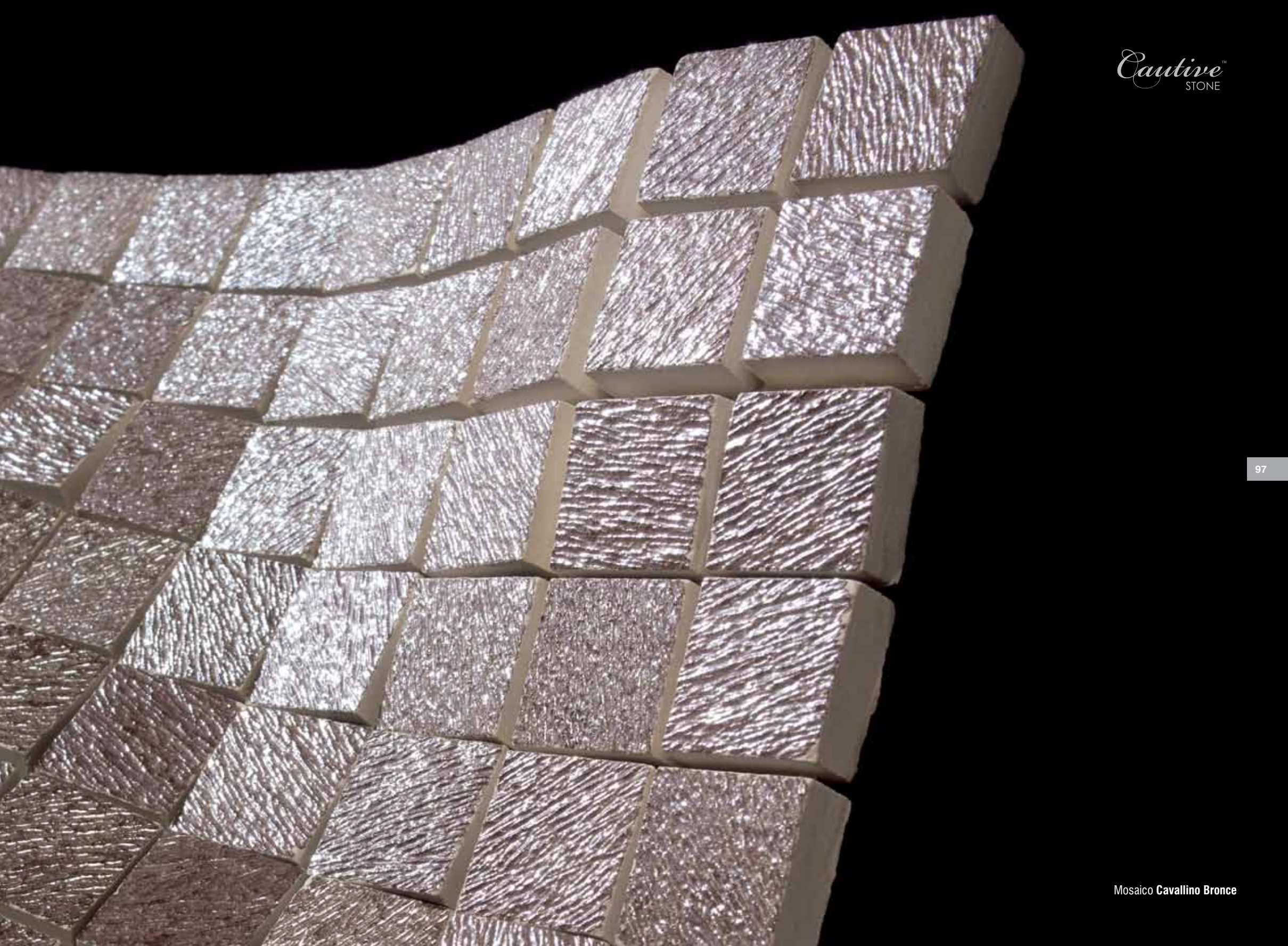

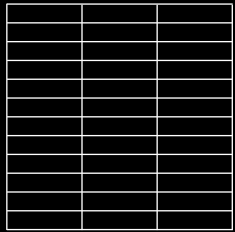

TESELA OXIDO / DUOMO MIX
30 x 30 / 11,7 x 11,7"
 25 x 100 x 10 mm

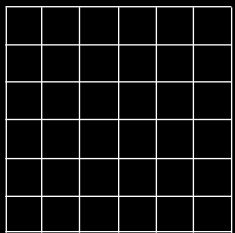

MOSAICO OXIDO / DUOMO MIX
30 x 30 / 11,7 x 11,7"
 48 x 48 x 10 mm



Mosaico Duomo Mix

Tesela Duomo Mix

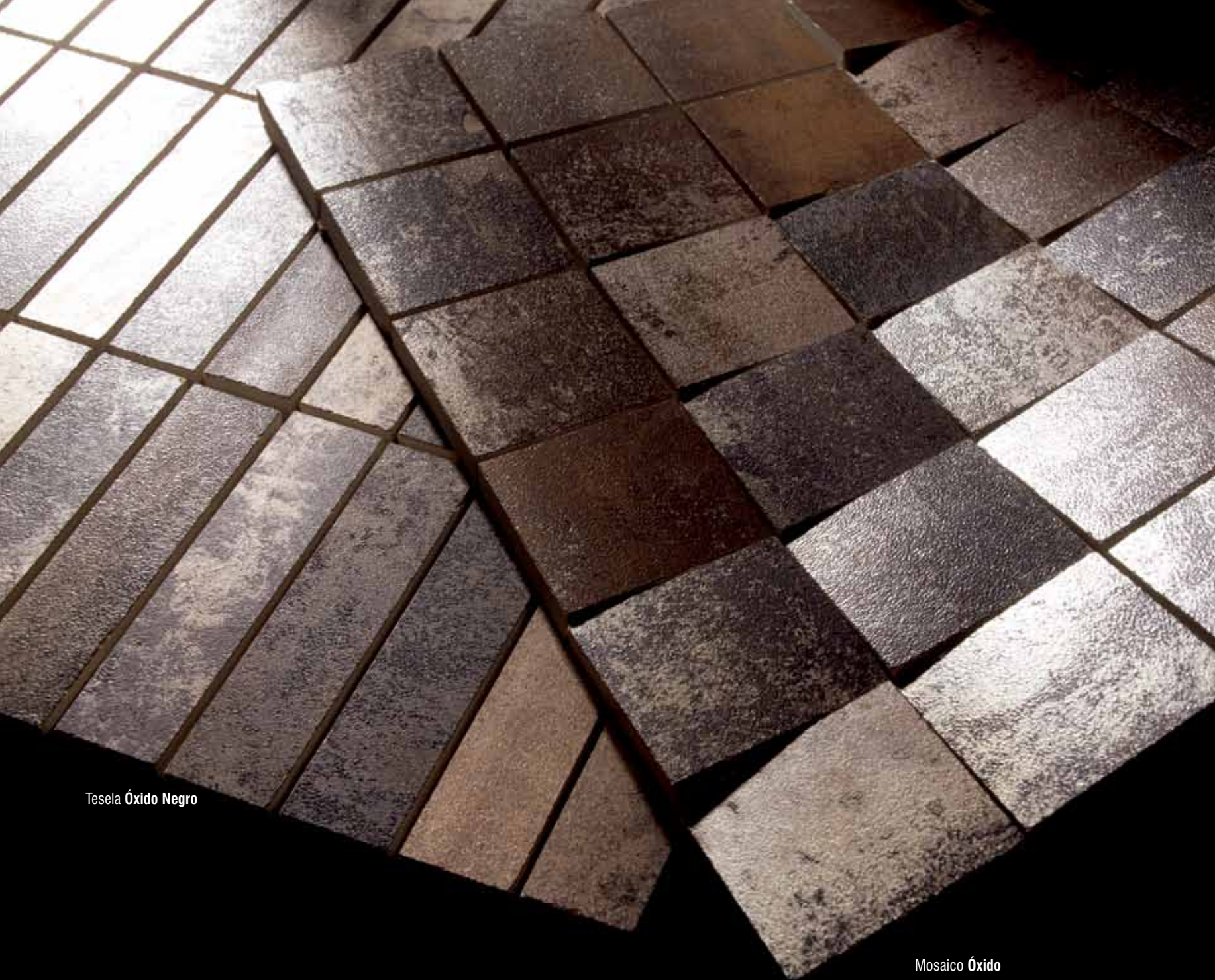

Tesela Óxido Negro

Mosaico Óxido

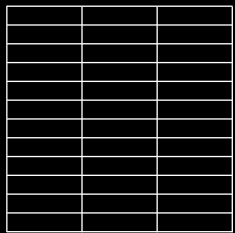

TESELA
30 x 30 / 11,7 x 11,7"
■ 25 x 100 x 10 mm

ceramic STONE

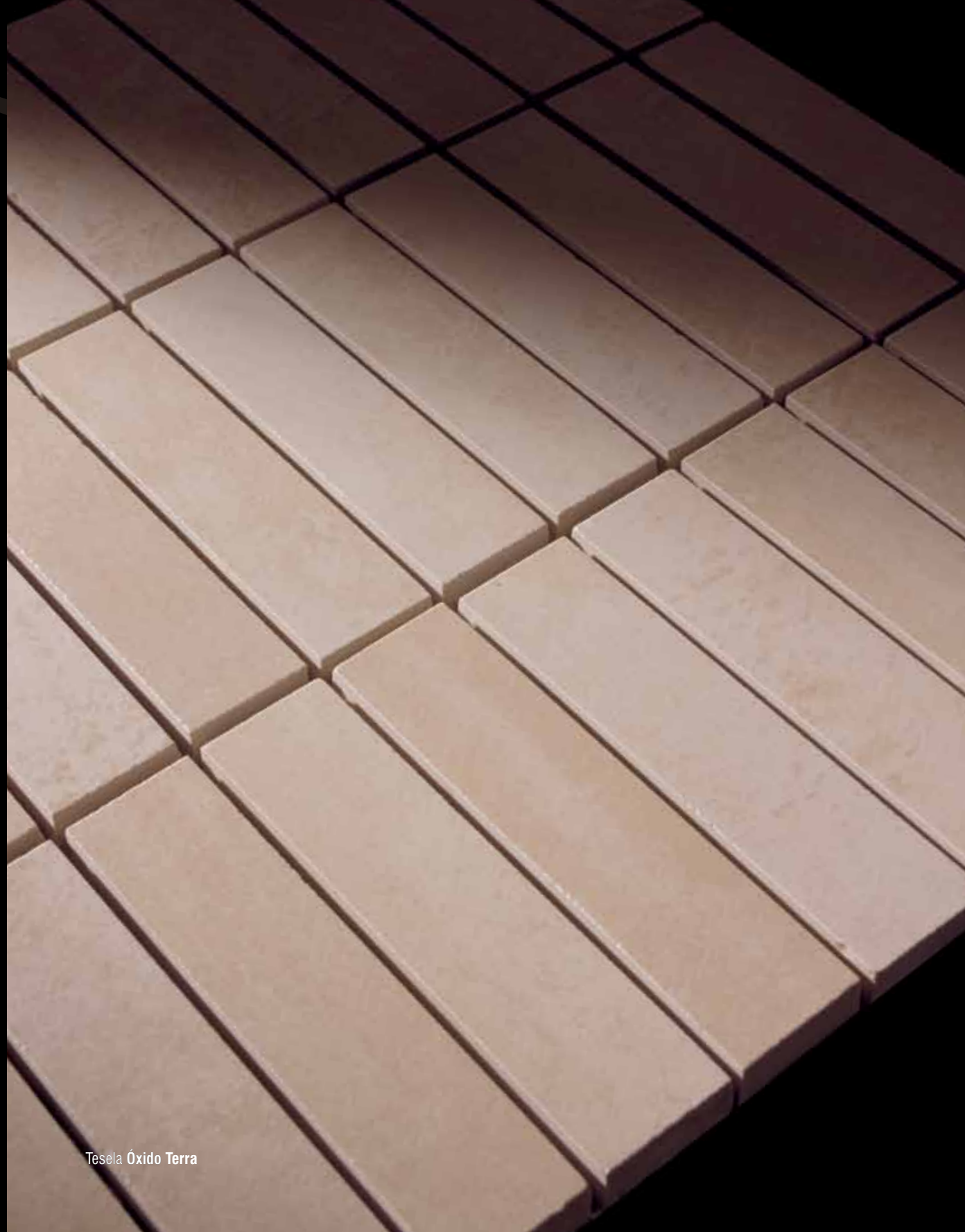

Tesela Óxido Terra





Tesela Bergen Mix Roble / Wengué

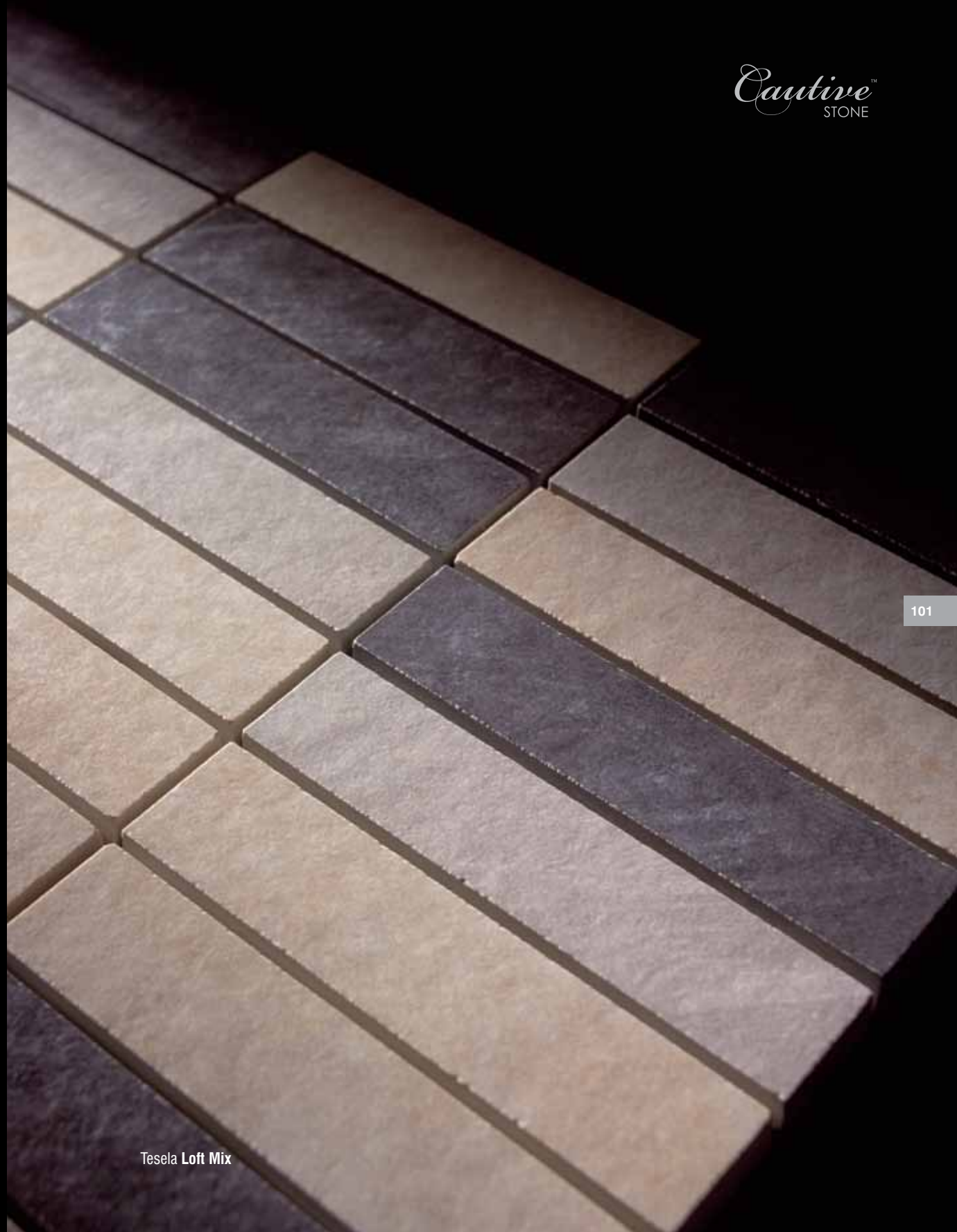

Tesela Loft Mix



Mosaico Cavallino Nacar



Mosaico Cavallino Gold

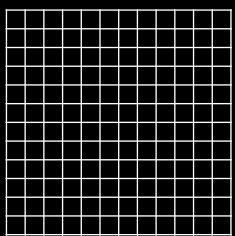

MOSAICO CAVALLINO
30 x 30 / 11,7 x 11,7"
15 x 15 x 10 mm

ceramic STONE



Mosaico Cavallino Crema / Leopard

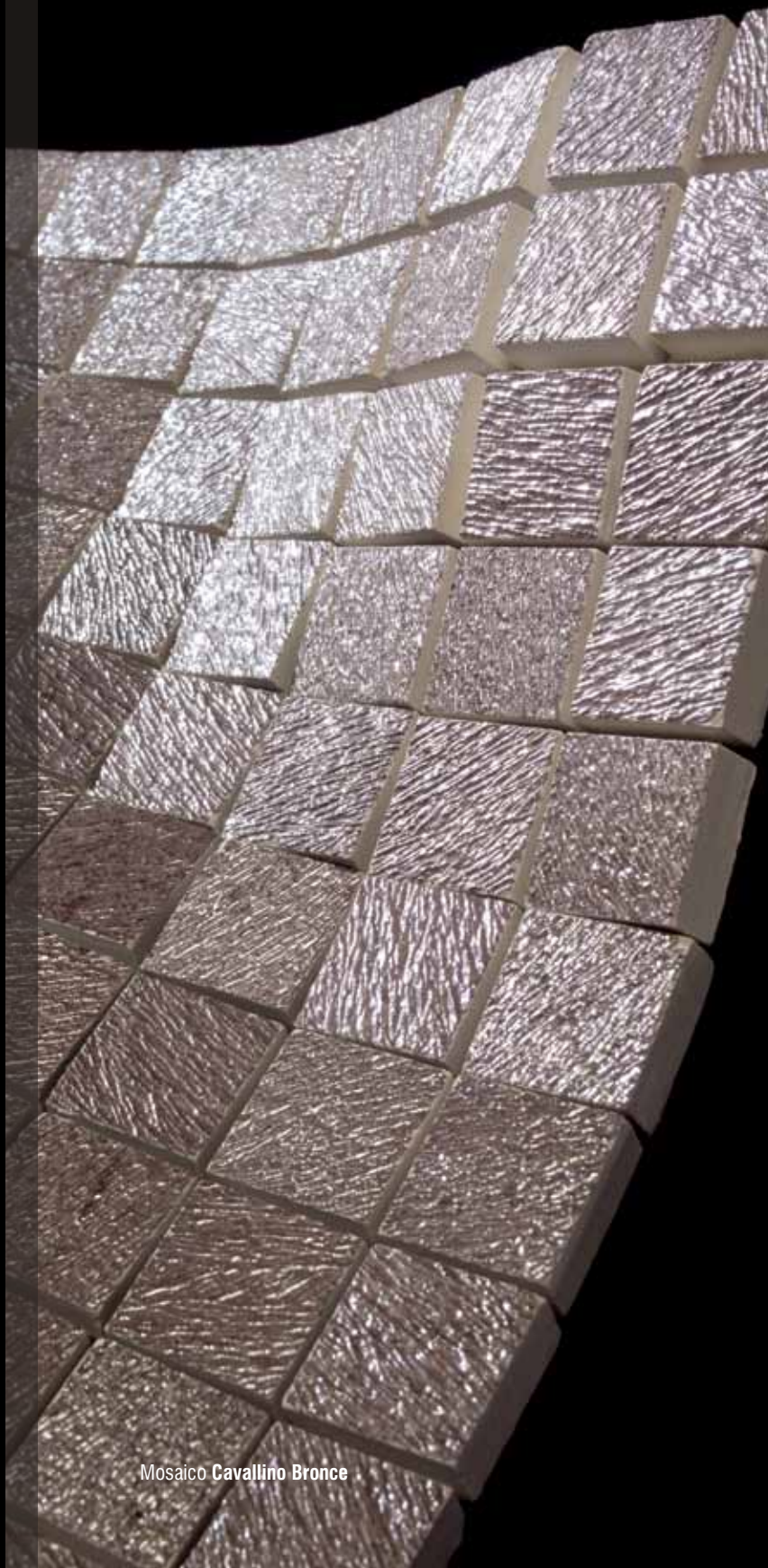

Mosaico Cavallino Bronce

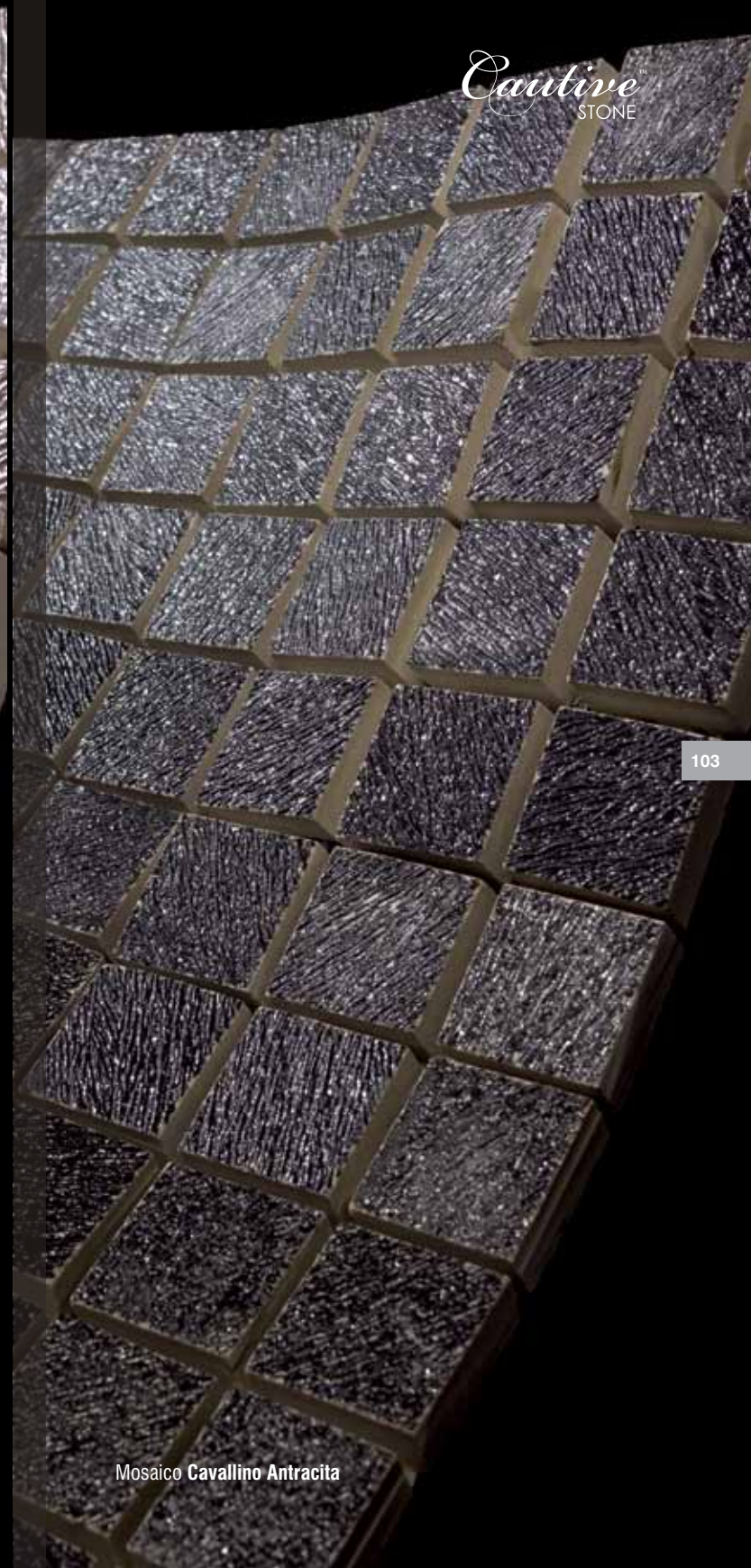

Mosaico Cavallino Antracita



MOSAICO OXIDO
30 x 30 cm / 11,7 x 11,7"
SP2037



TESELA OXIDO NEGRO
30 x 30 cm / 11,7 x 11,7"
SP2039



TESELA OXIDO TERRA
30 x 30 cm / 11,7 x 11,7"
SP2039



MOSAICO DUOMO MIX
30 x 30 cm / 11,7 x 11,7"
SP2037



TESELA DUOMO MIX
30 x 30 cm / 11,7 x 11,7"
SP2039



TESELA LOFT MIX
30 x 30 cm / 11,7 x 11,7"
SP2042

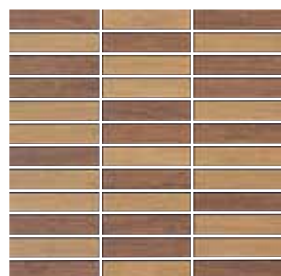

TESELA BERGEN MIX ROBLE / WENGUE
30 x 30 cm / 11,7 x 11,7"
SP2042

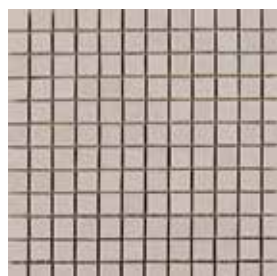

MOSAICO CAVALLINO NACAR
30 x 30 cm / 11,7 x 11,7"
SP2044



MOSAICO CAVALLINO CREMA / LEOPARD
30 x 30 cm / 11,7 x 11,7"
SP2044

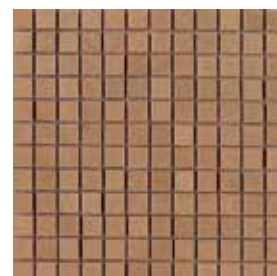

MOSAICO CAVALLINO GOLD
30 x 30 cm / 11,7 x 11,7"
SP2044



MOSAICO CAVALLINO BRONCE
30 x 30 cm / 11,7 x 11,7"
SP2044

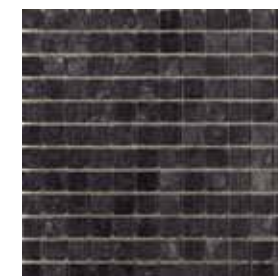

MOSAICO CAVALLINO ANTRACITA
30 x 30 cm / 11,7 x 11,7"
SP2044

PACKING LIST

DESCRIPCIÓN DESCRIPTION DESCRIPTION	FORMATO SIZE FORMAT	MEDIDA MEASURE MESURE	PZ/CAJA PC/BOX PZ/CAISE	PESO/PZ WEIGHT/PZ POIDS/PZ	PESO/CAJA WEIGHT/BOX POIDS/CAISSE
Mosaico Oxido	30x30	48x48x10	9	1,90	17,10
Tesela Oxido Negro	30x30	25x100x10	9	1,90	17,10
Tesela Oxido Terra	30x30	25x100x10	9	1,90	17,10
Mosaico Duomo Mix	30x30	48x48x10	9	1,90	17,10
Tesela Duomo Mix	30x30	25x100x10	9	1,90	17,10
Tesela Loft Mix	30x30	25x100x10	9	1,90	17,10
Tes. Bergen Mix Roble / Wengue	30x30	25x100x10	9	1,90	17,10
Mosaico Cavallino Nacar	30x30	15x15x10	9	1,66	14,90
Mos. Cavallino Crema/Leopard	30x30	15x15x10	9	1,66	14,90
Mosaico Cavallino Gold	30x30	15x15x10	9	1,66	14,90
Mosaico Cavallino Bronce	30x30	15x15x10	9	1,66	14,90
Mosaico Cavallino Antracita	30x30	15x15x10	9	1,66	14,90

CIFRE GROUP TM

Ctra. Vila-real - Onda, km 10
12200 Onda - Castellón SPAIN
Tel.: +34 964 506 969
Fax: +34 964 521 593

www.captivebycifre.com
www.cifregroup.com

STONE, CONSEJOS DE COLOCACIÓN Y MANTENIMIENTO

COLOCACIÓN

Es importante examinar las piezas antes de la colocación. Se recomienda mezclar el contenido de diferentes cajas para que la variación de tonos de la piedra natural sea homogénea.

También es vital la selección de los materiales que se emplearán en la colocación. Es necesario emplear colas apropiadas para piedras naturales, así como aplicar una capa aislante en las duchas y zonas húmedas. Si se emplea crucetas, no deben superar los 5mm.

En el caso de los mármoles travertinos y envejecidos, es posible que aparezcan agujeros superficiales que no deben rellenarse con ninguna resina, sino que se cubren con pasta de rejuntar. Se recomienda emplear tonos claros para la pared y tonos oscuros para pavimentos.

Después de rejuntar tanto los agujeros como las juntas, es necesario eliminar los restos de adhesivo superficial para evitar que se seque. Emplee una esponja humedecida con agua para retirar los restos de material y productos de limpieza con pH neutro para tratar habitualmente la piedra, nunca productos abrasivos.

PRODUCTOS DE PROTECCIÓN

Es importante emplear productos de protección para proteger la piedra de la humedad y la suciedad, ya que se trata de un material absorbente. La superficie debe estar completamente limpia y seca antes de aplicar cualquier producto protector. Estos productos deben colocarse en ambientes muy ventilados y con temperaturas superiores a los 5° C.

- Sellador antimanchas: repele el aceite y el agua y penetra fácilmente en la piedra sin formar películas ni alterar el color original. Se puede utilizar tanto en interior como en exterior, es estable a los rayos UV y permite transpiración. Cuando se emplee materiales muy absorbentes, se recomienda repetir la operación.
- Cera líquida protectora: Es un abrillantador de fácil aplicación para mármoles y piedras. Realza los colores de mármol y es resistente a la luz, no amarillea y resiste a los ácidos. Se aplica con un paño humedecido y se repasa posteriormente con paño seco o mopa. Se recomienda utilizarlo después de haber aplicado el sellador antimanchas.

OBSERVACIONES

Los productos de Captive Stone están elaborados con piedra natural y, por tanto, están formados por piezas únicas, con tonos y matices que los convierten en únicos.

***Le recomendamos tratar estos productos con productos para detener los efectos de la humedad. De lo contrario, las piezas podrían terminar mostrando signos de oxidación.**

COLOCACIÓN MALLAS CON COMPONENTES DE PIEDRA

COLOCACIÓN

Es necesario comprobar que la superficie en la que se va a colocar la malla se encuentra en perfectas condiciones: limpia y lisa para que el resultado final sea el adecuado.

Hay que ser especialmente cuidadoso con la selección del adhesivo, ya que los recomendados para este tipo de material son Cemento cola C2 u otros adhesivos epoxídicos. Una vez se haya seleccionado el adhesivo correspondiente, es importante seguir atentamente las instrucciones del fabricante para su preparación, tanto en tiempo de secado como de colocación, etc, para obtener una masa homogénea.

Con el material ya preparado, se extiende una capa fina de adhesivo, de un mínimo de 3 mm de espesor, sobre la superficie escogida para la colocación el material. La pieza se coloca mientras el material esté blando aún ya que, de lo contrario, se puede secar la capa superior. Una vez colocada la pieza, se debe retirar los restos de material antes de que se seque.

Es importante garantizar que la distancia entre las mallas es la misma que queda entre cada una de las piezas para lograr un resultado homogéneo.

REJUNTADO

El rejuntado de las piezas no se produce hasta que el adhesivo haya secado completamente. De nuevo, sea especialmente cuidadoso a la hora de escoger el material de rejuntado y siga las instrucciones del fabricante respecto a la preparación y a los tiempos de aplicación y de secado. Elimine cualquier resto de pasta de la superficie de la pieza con esponja y agua clara.

MANTENIMIENTO

Evite utilizar productos abrasivos y use para la limpieza agua o productos de PH neutro. Si la malla se va a utilizar como pavimento, se recomienda el empleo de un producto sellador.

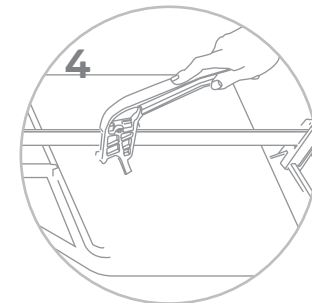

STONE, RECOMMENDATIONS FOR LAYING AND MAINTENANCE

LAYING

It is important to examine the pieces before laying. It is recommended to mix the content of different boxes so that the variation of shades in the natural stone is homogenous.

The selection of the materials for laying is also vital. It is essential to use adhesives that are suitable for natural stone, and to apply a sealant layer in showers and wet areas. If spacers are used, they must not be larger than 5 mm.

In the case of travertine or aged marbles, it is possible that holes will appear in the surface. These must not be filled with resin of any type, but covered with grout. Light-coloured grouting material is recommended for walls and dark colours for paving.

After grouting any holes and all the joints, all residues of grouting material on the surface must be removed before it sets. Use a sponge moistened in water to remove residues of material. For routine cleaning use pH-neutral detergents, never abrasive cleaners.

PROTECTIVE PRODUCTS

It is important to use appropriate products to protect the stone from damp and dirt, because it is an absorbent material. The surface must be completely clean and dry before applying any protective product. These products must be used in a well-ventilated area at temperatures no less than 5° C.

Anti-stain sealant: repels oils and water and penetrates easily into the stone without forming a film or altering the original colour. It can be used in interiors or exteriors, is not affected by UV light and allows transpiration. When it is used on very absorbent materials, it is recommended to repeat the operation.

Protective liquid wax: an easily-applied polishing agent for marble and stone. Brings out the colours in marble, is resistant to light, does not yellow and resists acids. It is applied with a damp cloth and then finished with a dry cloth or mop. It is recommended it be used after applying anti-stain sealant.

NOTE

Cautive Stone products are made of natural stone and hence the exact colour and shade varies from piece to piece, making each one unique.

TILING MESH WITH STONE COMPONENTS

TILING

For good results it is essential to ensure the surface on which the mesh is to be applied is perfectly clean and level. Particular care must be taken with the choice of the adhesive; recommended for this task are C2 tile cement or other epoxy-based adhesives. Having selected the appropriate adhesive, it is important to follow the manufacturer's preparation instructions closely, with regard to setting and laying time, etc., and to obtain a homogenous mass.

Having prepared the material, a layer of adhesive at least 3 mm thick is applied to the laying surface. The piece is positioned while the material is still soft, as otherwise the top layer may dry out. Having positioned the piece, residues of adhesive must be removed before they dry.

It is important to ensure that the distance between meshes is the same as that between each piece, in order to achieve an even result.

GROUTING

Grouting is not carried out until the adhesive is completely set. Once again, be very careful when choosing the grouting material and follow the manufacturer's instructions on preparation and on laying and setting times. Remove all residues from the surface of the pieces with a sponge moistened in plain water.

MAINTENANCE

Do not use abrasive products; use plain water or pH-neutral products. If the mesh is for use as paving, it is recommended to apply a sealant.

Evite utilizar productos abrasivos y use para la limpieza agua o productos de PH neutro. Si la malla se va a utilizar como pavimento, se recomienda el empleo de un producto sellador.

STONE, CONSEILS DE POSE ET ENTRETIEN

POSE

Il est important d'examiner les pièces avant la pose. Il est recommandé de mélanger le contenu de différentes boîtes pour que la variation de tons de la pierre naturelle soit homogène.

Il est également essentiel de sélectionner les matériels qui seront employés pendant la pose. Il faut employer des colles appropriées pour des pierres naturelles, ainsi qu'appliquer une couche isolante dans les douches et les zones humides. Si

des croisillons sont employés, ils ne doivent pas dépasser 5 mm.

Dans le cas des marbres travertins et vieilliss, il est possible qu'il apparaisse des trous superficiels qui ne doivent être remplis d'aucune résine, mais être couverts d'une pâte à rejoinoyer. Il est recommandé d'employer des tons clairs pour le mur et

des tons foncés pour les pavements.

Après le rejoinoyage des trous et des joints, il faut éliminer les restes d'adhésif superficiel pour éviter qu'il sèche. Employez une éponge humidifiée d'eau pour retirer les restes de matériel et des produits de nettoyage à pH neutre pour traiter habituellement la pierre, jamais de produits abrasifs.

PRODUITS DE PROTECTION

Il est important d'utiliser des produits de protection pour protéger la pierre de l'humidité et la saleté, vu qu'il s'agit d'un matériel absorbant. La surface doit être entièrement propre et sèche avant d'appliquer un produit protecteur. Ces produits doivent être placés dans des ambiances très aérées et avec des températures supérieures à 5° C.

Agent de scellage antitaches : repousse l'huile et l'eau et pénètre facilement dans la pierre sans former de films ni altérer la couleur d'origine. Il peut être utilisé aussi bien à l'intérieur qu'à l'extérieur, il est stable aux rayons UV et permet la transpiration. Quand des matériels très absorbants sont utilisés, il est recommandé de répéter l'opération.

Cire liquide protectrice : il s'agit d'un polissoir facile à appliquer pour marbres et pierres. Elle rehausse les couleurs du marbre et elle est résistante à la lumière, ne jaunit pas et résiste aux acides. Elle est appliquée avec un chiffon humidifié puis elle est ensuite essuyée avec un chiffon doux ou une lavette. Il est recommandé de l'utiliser après avoir appliqué l'agent de scellage antitaches.

OBSERVATIONS

Les produits de Cautive Stone sont élaborés avec une pierre naturelle et, par conséquent, ils sont composés de pièces uniques, avec des tons et des nuances qui les rendent uniques.

POSE DE MAILLES AVEC DES COMPOSANTS EN PIERRE

POSE

Il est nécessaire de vérifier que la surface sur laquelle sera placée la maille se trouve dans un parfait état : propre et lisse pour que le résultat final soit approprié.

Il faut faire particulièrement attention en sélectionnant l'adhésif, vu que ceux recommandés pour ce type de matériel sont la ciment-colle C2 ou d'autres adhésifs époxydiques. Une fois sélectionné l'adhésif correspondant, il est essentiel de suivre attentivement les instructions du fabricant pour sa préparation, aussi bien quant au temps de séchage que de pose, etc., pour obtenir une pâte homogène.

Quand le matériel est prêt, étaler une couche fine d'adhésif, d'au moins 3 mm d'épaisseur, sur la surface choisie pour la pose du matériel. La pièce est placée tant que le matériel est encore mou vu que, sinon, la couche supérieure peut sécher. Une fois placée la pièce, il faut retirer les restes de matériel avant qu'ils sèchent.

Il est important de garantir que la distance entre les mailles est la même qui se trouve entre chacune des pièces pour obtenir un résultat homogène.

REJOINTOYAGE

Le rejoinoyage des pièces ne se produit pas tant que l'adhésif n'a pas entièrement séché. À nouveau, il faut faire spécialement attention au moment de choisir le matériel de rejoinoyage et suivre les instructions du fabricant quant à la préparation et aux temps d'application et de séchage. Éliminez tout reste de pâte de la surface de la pièce à l'aide d'une éponge et d'eau propre.

ENTRETIEN

Évitez d'utiliser des produits abrasifs et, pour le nettoyage, utilisez de l'eau ou des produits à pH neutre. Si la maille est utilisée comme pavement, il est recommandé d'employer un produit de scellage.